



USER MANUAL

D9 Smart Diagnostics System



Please read this user manual carefully before using the D9 Smart Diagnostics System. When reading the manual, please pay attention to the words “Note” or “Caution” and read them carefully for appropriate operation.

TRADEMARKS

XTOOL is a registered trademark of Shenzhen Xtooltech Intelligent CO., LTD. In countries where the trademarks, service marks, domain names, logos, and the name of the company are not registered, Xtool claims that it still reserves the ownership of the unregistered trademarks, service marks, domain names, logos, and the company name. All other marks for the other products and the company’s name mentioned in the manual still belong to the original registered company.

You may not use the trademarks, service marks, domain names, logo, and company name of Xtool or other companies mentioned without written permission from the trademark holder.

Xtool reserves the right to the final interpretation of this manual content.

COPYRIGHT

Without the written consent of Shenzhen Xtooltech Intelligent Co., Ltd., any company or individual shall not copy or backup this operation manual in any form (electronic, mechanical, photocopying, recording, or other forms).

DECLARATION

This manual is designed for the usage of the D9 Smart Diagnostics System and provides operating instructions and product descriptions for users of the D9 Smart Diagnostics System.

No part of this manual can be reproduced, stored in a retrieval system, or transmitted, in any form or by any means (electronic, mechanical, photocopying, recording, or otherwise), without the prior written permission of Xtool.

Use the device only as described in this manual. Xtool is not responsible for any consequences of violating the laws and regulations caused by using the product or its data information

Xtool shall not be liable for any incidental or consequential damages or for any economic consequential damages arising from the accidents of individual users and the third parties, misuse or abuse of the device, unauthorized change or repair of the device, or the failure made by the user not to use the product according to the manual.

All information, specifications, and illustrations in this manual are based on the latest configurations and functions available at the time of printing. Xtool reserves the right to make changes at any time without notice.

OPERATION INSTRUCTIONS

For safe operation, please follow the instructions below:

- Keep the device away from heat or fumes when you are using it.
- If the vehicle battery contains acid, please keep your hands and skin or fire sources away from the battery during testing.
- The exhaust gas of the vehicle contains harmful chemicals, please ensure adequate ventilation.
- Do not touch the cooling system components or exhaust manifolds when the engine is running due to the high temperatures reached.
- Make sure the car is securely parked, Neutral is selected or the selector is at P or N position to prevent the vehicle from moving when the engine starts.
- Make sure the (DLC) diagnostic link connector is functioning properly before starting the test to avoid damage to the Diagnostic Tablet.
- Do not switch off the power or unplug the connectors during testing, otherwise, you may damage the ECU and/or the Diagnostic Tablet.

CAUTIONS!

- Avoid shaking or dismantling the unit as it may damage the internal components.
- Do not use hard or sharp objects to touch the LCD screen;
- Do not use excessive force;
- Do not expose the screen to strong sunlight for a long period.
- Please keep it away from water, moisture, high temperature, or very low temperature.
- If necessary, calibrate the screen before testing to ensure the accuracy of LCD performance.
- Keep the main unit away from strong magnetic fields.
- Please keep your device always connected to the Internet. When the device is off the Internet for 30 days, The Diagnostics APP may be locked and you need to synchronize data with the Internet to activate it.

AFTERSALES-SERVICES



E-Mail: supporting1@xtooltech.com

supporting2@xtooltech.com



Tel: +86 755 21670995 or +86 755 86267858 (China)

Monday through Friday

09:00~18:30 (UTC/GMT+08:00)



Official Website: www.xtooltech.com

① Please provide your device serial number, VIN code, vehicle model, software version, and other details when seeking technical support. If there are screenshots or videos, it will better help us locate your problem.

Content

TRADEMARKS	I
COPYRIGHT	I
DECLARATION	I
OPERATION INSTRUCTIONS	I
CAUTIONS!	II
AFTERSALES-SERVICES	II
1 GENERAL INTRODUCTION	1
1.1. Tablet Overview	1
Front View of Tablet	1
Back View of Tablet	2
Host Ports	2
1.2. VCI box	3
Front/Back View	3
Top/Bottom View	3
1.3. Technical Specifications	4
1.4. Packing Kit	5
2 GETTING STARTED	6
2.1. Activation	6
2.2. Main Interface	7
Operation System	7
Main Menu	9
Function Buttons	10
Navigation Buttons	10
Notification Bar	11
2.3. Factory Reset	11
3 UPDATE & DELETE	14
3.1. Update software	14
3.2. Delete Software	15
4 DIAGNOSTICS	16
4.1. Vehicle Connection	16
4.2. Vehicle Selection	17
4.3. Diagnostics Functions	20
5 SPECIAL FUNCTIONS	28
5.1. OIL RESET	29
5.2. EPB	30

5.3.	SAS.....	31
5.4.	DPF.....	33
5.5.	BMS RESET.....	37
5.6.	THROTTLE.....	39
5.7.	INJECTOR CODING.....	40
5.8.	GEARBOX MATCH.....	42
5.9.	GEAR LEARNING.....	43
6	REPORT.....	45
6.1.	Report.....	45
6.2.	Replay.....	47
6.3.	File Manager.....	48
7	SETTINGS.....	48
7.1.	Language.....	49
7.2.	Units.....	50
7.3.	Bluetooth.....	50
7.4.	My Workshop Info.....	51
7.5.	VCI Information.....	51
7.6.	About.....	52
8	REMOTE ASSISTANCE.....	53
9	FAQ.....	54
	Q1: Failed to generate Diagnostics report.....	54
	Q2: How to print Diagnostics report.....	55
	Q3: Failed to extract files.....	55
	Q4: Mailbox supported.....	56
	Q5: How to make an appointment for remote support.....	56
	Q6: How to generate and upload diagnostic log files.....	56
	Q7: How to switch language.....	56
	Q8: Failed to diagnose vehicle.....	56
	Q9: Failed to activate or register.....	56
	Q10: Failed to turn on when charging.....	57
	Q11: Failed to open the Diagnostics app.....	57
	Q12: Failed to enter Vehicle menu.....	57
10	WARRANTY & SERVICES.....	59

1 GENERAL INTRODUCTION

The D9 smart Diagnostics system is an advanced scanning tool based on the Android operating system. It supports multi-language switching and is suitable for different countries and regions.

The advantage of this scanner is not only its comprehensive functions, including complete system Diagnostics, full OBDII functions, various reset functions can also achieve a faster and more accurate Diagnostics.

The D9 Smart Diagnostics system mainly includes:

- Tablet
- VCI box
- Main test cable
- Connectors
- Power adapter

Before performing the Diagnostics program, please make sure that the VCI box is successfully connected to your vehicle, and connect the VCI box with Bluetooth on the tablet.

Some old cars with non-OBD2 standard protocol need to be connected with our VCI box through specific pin connectors.

Using the wrong connector may cause your car to be unrecognized by the diagnostic tool.

Please confirm the OBD connector specifications configured on your car before connecting.

1.1. TABLET OVERVIEW

The main unit of the D9 Smart Diagnostics System is the tablet. It allows you to operate all Diagnostics functions, and it can also work as a normal Android tablet.

FRONT VIEW OF TABLET

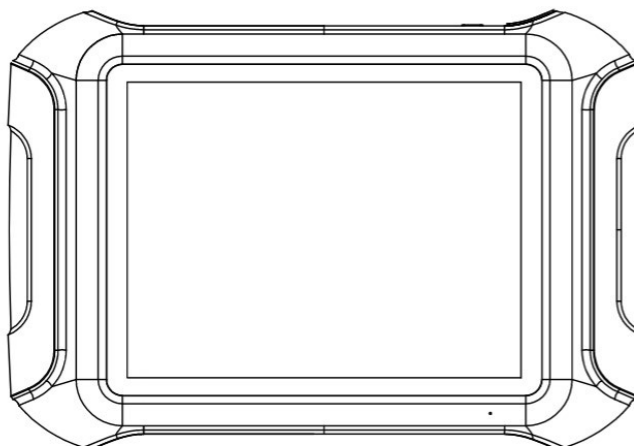

Figure 1-1 Sample of Tablet Front View

The front of the tablet is mainly a touchable display screen, you can use your fingers to operate on the screen to finish most of the Diagnostics process.

BACK VIEW OF TABLET

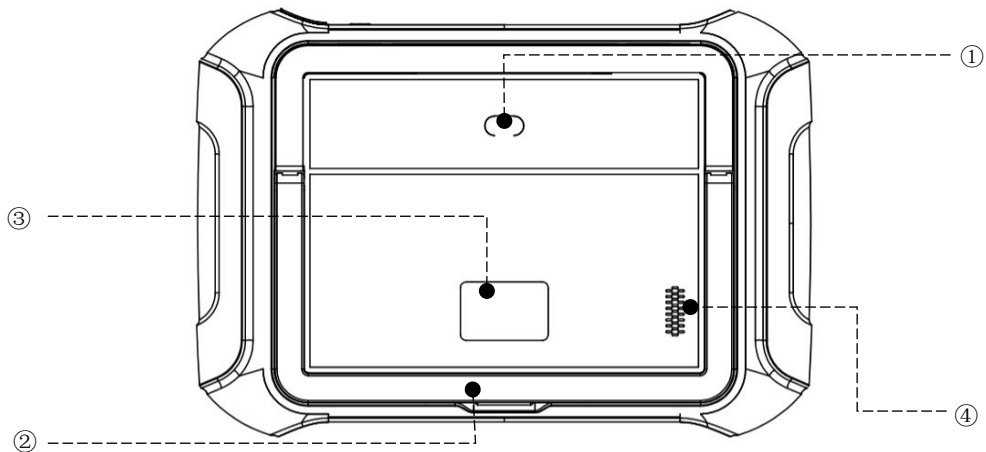

Figure 1-2 Sample of Tablet Back View

- ① **Camera:** Used for taking pictures.
- ② **Tablet Holder:** Used to support the tablet, hold the tablet on the steering wheel or adjust the tablet height as needed.
- ③ **Nameplate:** Show the basic information about the tablet such as product name and serial number, etc.
- ④ **Loudspeaker:** It supports external sound playback.

HOST PORTS

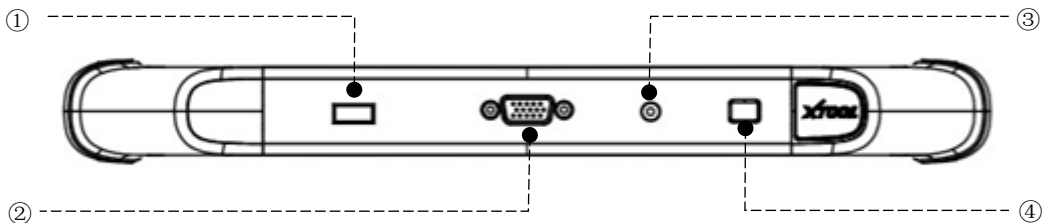

Figure 1-3 Sample of Tablet Host Ports

- ① **USB 3.0 port:** Used for data transfer for tablet & PC communication, and data transfer with VCI box when working, also supports ECU programming for vehicles with DOIP protocol
- ② **VGA port:** DB15 port, a reserved interface can be used for charging.
- ③ **DC charging port:** Charging port, connected to the power adapter to charge the device.
- ④ **Power button:** Long press to turn the device on/off, short press to switch the device into sleep mode. Hold for about 20 seconds to force shut down the device.

1.2. VCI BOX

To communicate with the vehicle via OBD, D9 also comes up with a VCI box. The tablet needs a Bluetooth connection with the VCI box to get access to all software.

Ⓚ Although some functions (like EEPROM Adapter) will not need you to communicate to the vehicle, please power up the VCI box using a 12V power adapter to get access to the software.

FRONT/BACK VIEW

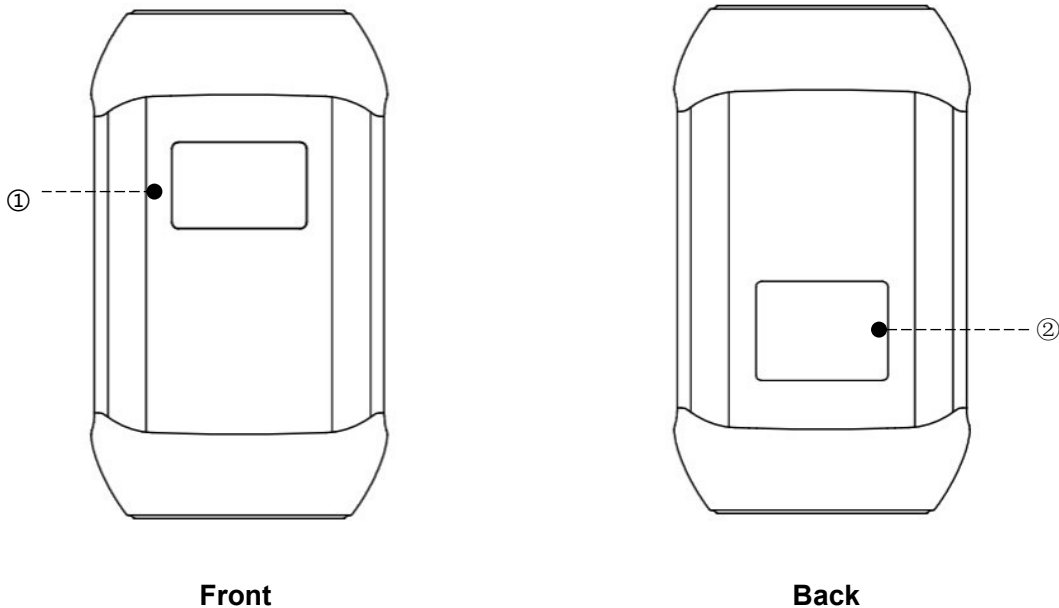

Figure 1-4 Sample of VCI Box, screen 1

- ① **Display Screen:** Show status of the VCI box-like battery voltage, Bluetooth connection, and car communication status.
- ② **Nameplate:** Show basic information about the VCI box, like the serial number.

Ⓚ Make sure that you're using the VCI box that is paired with the tablet, or it will not communicate. The serial number of the VCI box must be the same as the serial number of the tablet.

TOP/BOTTOM VIEW



Figure 1-5 Sample of VCI Box, screen 2

- ① **DB15 Port:** Used to connect the VCI box to the OBDII port on the vehicle.
- ② **USB-B Port:** Used to connect the VCI box to the tablet using USB-B to USB3.0 cable

1.3. TECHNICAL SPECIFICATIONS

Table 1-1 Specification

Item	Description
OS	Android System
Processor	Quad-core processor 1.8GHz
Ram	2 G
Rom	64G/128 G
Display	9.7-inch capacitive, 1024×768 resolution
Connectivity	<ul style="list-style-type: none"> ● USB ● Wi-Fi ● Bluetooth
Camera	8-megapixel autofocus rear camera with flash
Sensor	Gravity sensor
Audio Input/ Audio Output	Microphone/ Loudspeaker
Ports	<ul style="list-style-type: none"> ● USB3.0 ● DC charging port ● VGA port ● DOIP port
Battery	10000mAh 3.7V lithium polymer battery
Input Voltage	12V DC
Operating Temperature	-10~50°C
Relative Humidity	< 90%
Dimensions	315.07×218.35×34.61 mm

1.4. PACKING KIT

Table 1-2 Packing List

Category	No.	Name	QTY
Test connector	1	HONDA-3	1
	2	TOYOTA-17	1
	3	BMW-20	1
	4	KIA-20	1
	5	MAZDA-17R	1
	6	NISSAN-14	1
	7	GM/DAEWOO-12	1
	8	SUZUKI-3	1
	9	FIAT-3	1
	10	HYUNDAI/KIA-10	1
	11	AUDI-4	1
	12	MINI-12+16	1
	13	UNIVERSAL-3	1
	14	CITROEN-2	1
	15	BENZ-38	1
	16	BENZ-14	1
	17	SELFTEST	1
	18	OBD II-16	1
	19	DB15 Main Cable	1
	20	Battery Cable	1
	21	Cigar Lighter Cable	1
Host group	1	Tablet PC	1
	2	VCI Box	1
	3	USB3.0 To Type_B Main Cable	1
	4	Charger for Tablet	1
	5	Power Cable US	1
	6	Power Cable EU	1
	7	USB3.0 Data Cable (Connect to PC)	1
Accessories	1	Color Carton	1
	2	Packing List	1
	3	Certificate of Quality	1
	4	Tool Case	1
	5	Desiccant	4
	6	User Manual	1

2 GETTING STARTED

2.1. ACTIVATION

After first-time users press and hold the power button to turn on the system, the system will automatically enter the guide process and request to select the language for the operating system.



Figure 2-1 Sample of Selection Languages

After setting the system language, you will enter the activation page, as shown in the figure below. You can also click the "Trial" button in the upper right corner to try it out before activation.

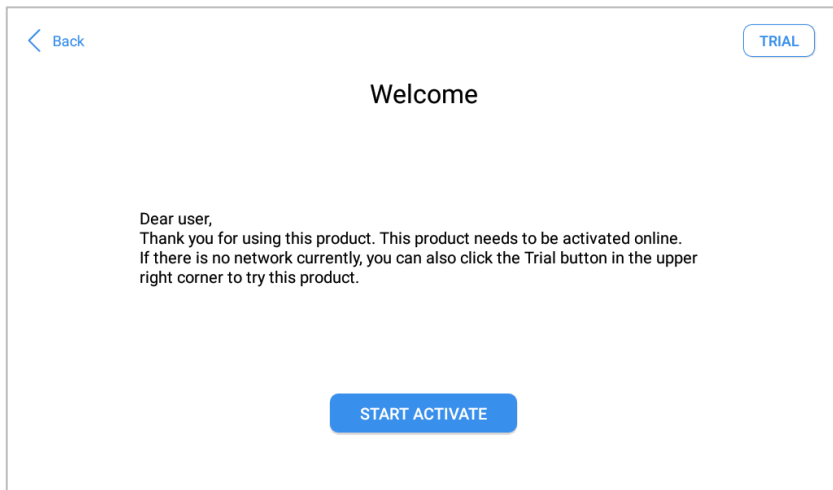

Figure 2-2 Sample of Activation (Screen 1)

Click **Start Activate** to enter the activation page, as shown below:

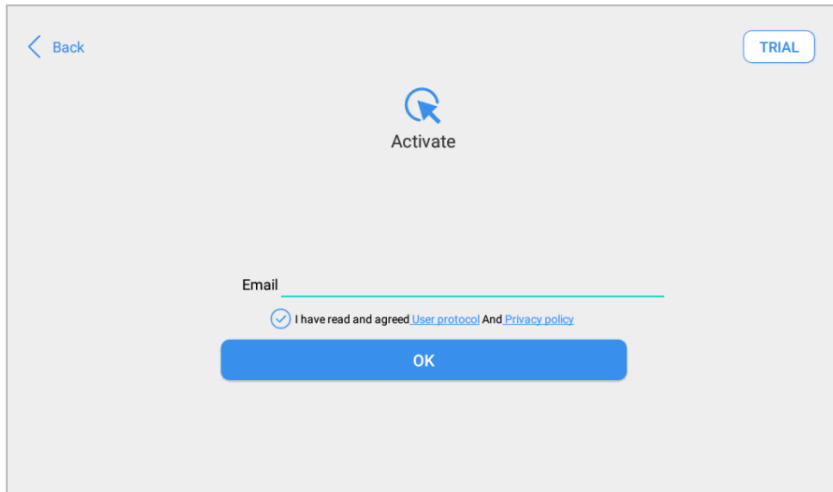

Figure 2-3 Sample of Activation (Screen 2)

A pop-up window showing **Activation Success** indicates that you have completed the first boot setup, click **OK** to enter the diagnostic system and start using the device.

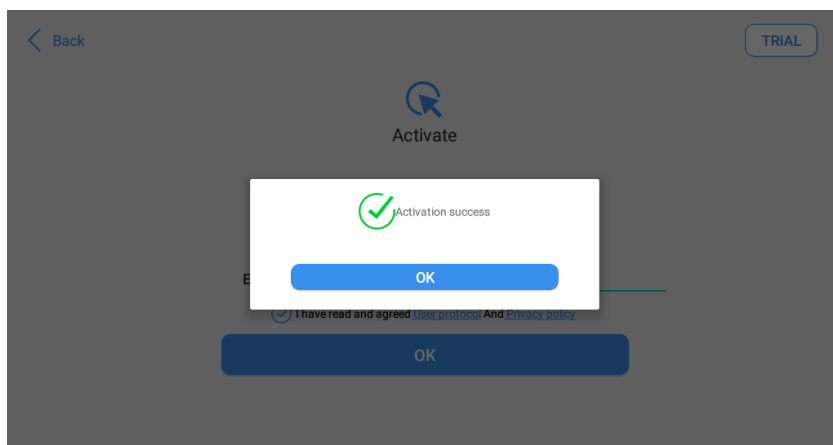

Figure 2-4 Sample of Activation (Screen 3)

2.2. MAIN INTERFACE

OPERATION SYSTEM

The picture below (Fig 2-5) is the home screen of the operating system of the device. You can also return to this interface at any time by clicking the home button on the bottom navigation bar.

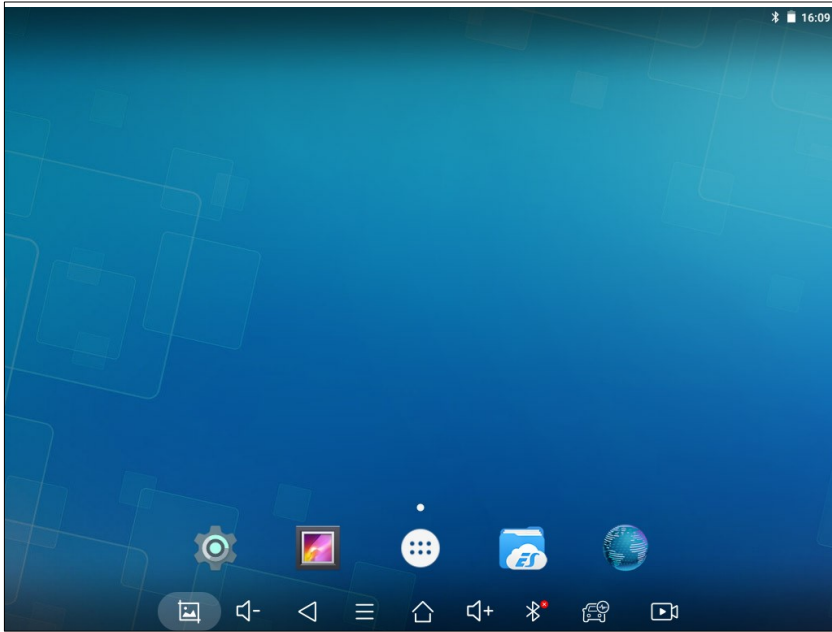







Figure 2-5 Sample of OS Main page

The app icons are as follows:

Table 2-1

Items	Descriptions
	Browser
	Gallery
	Application Menu
	ES File Explorer
	Android Settings
	D9 SMART DIAGNOSTICS SYSTEM

- a) **Browser:** Click on the browser icon to enter the browser to view the official website of Xtool or search for other information.
- b) **Gallery:** Click the **Gallery** icon to enter the album and you can quickly view the pictures or screenshots stored on the device. You can select the picture you need, click the share button on the upper right, and send the picture to your mobile phone or PC via Bluetooth or USB connection
- c) **Application Menu:** Show all the apps that you have installed into the device, also allows you to manage them.
- d) **ES File Explorer:** You can manage APP, music, files, pictures, etc. in the device in this function, and you can also use Local/Home/Cleaner to clean up files.

ⓘ If you need to check the files inside the D9 Smart Diagnostics System app (not recommended), please use the file explorer inside the D9 Smart Diagnostics System app.

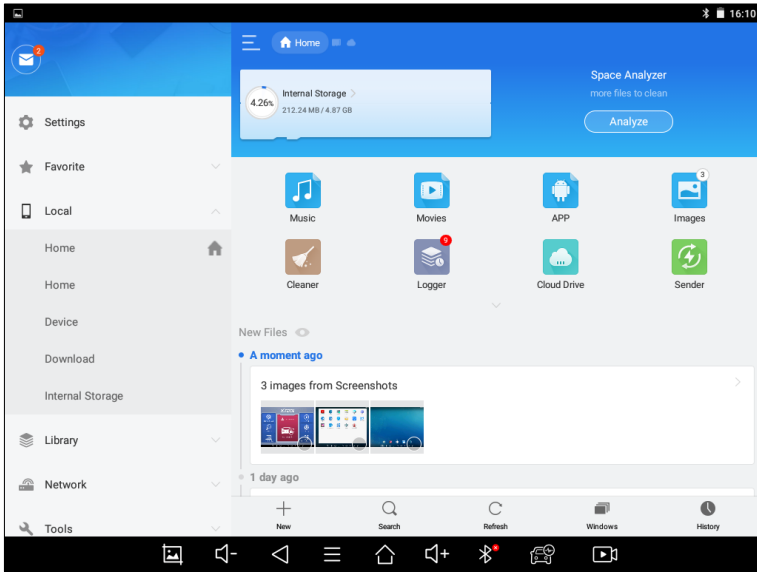

Figure 2-6 Sample of ES File Explorer

- e) **Android Settings:** This allows you to check and change the settings of the Android system, including network, battery status, language, device info, and factory reset.
- f) **D9 Smart Diagnostics System:** This app provides full system diagnostic functions and also offers a range of specialist maintenance services.

It will be referred to as the “D9 Smart Diagnostics System App” later in this manual.

MAIN MENU

Every time start the tablet, you will automatically enter the D9 Smart Diagnostics System app with the following main screen. Tap on the Diagnostics application button on the menu, the main menu will be shown as below:











Figure 2-7 Sample of APP Main Page

This main menu contains Function Buttons and Navigation Buttons. The touch screen navigation is made up of several menus, and you can quickly access functions by clicking on the icons. A detailed description of the menu structure can be found in the next section **Function Buttons**.

FUNCTION BUTTONS

The following table briefly describes each function button.







Table 2-2



Icon	Description
	Auto Scan for vehicle
	Includes various special functions for vehicles
	Enter vehicle Diagnostics menu
	Enter TeamViewer for remote support
	Update the software through the Internet
	Select the language and unit shown in the app, and check the Bluetooth status, device info, and workshop info
	View extended functions like checking reports and checking the Xtool official website
	Check the Diagnostics report that is recorded on your device, prints it as PDF files, or share it with other devices

NAVIGATION BUTTONS

Instructions for operating the navigation bar buttons at the bottom of the screen, as described in the table below:

Table 2-3

Items	Descriptions
	Press for screenshot
	Decrease volume
	Back to the previous interface
	Shows recently used applications
	Back to the main interface of the Android system
	Increase volume
	Showing the Bluetooth states

	Click this button to return to the diagnostic vehicle interface
	Press for screen recording

NOTIFICATION BAR

Slide down to open the notification bar. You can adjust the brightness of the screen when you need it, and you can also connect Wi-Fi and so on.

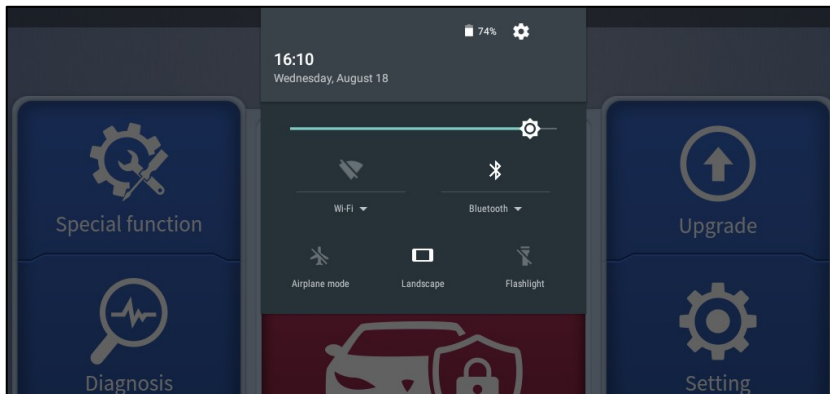

Figure 2-8 Sample of NOTIFICATION BAR

2.3. FACTORY RESET

After using the device for the first time or resetting the factory settings to the device, the system will automatically enter the Activation Guide program.

This page allows you to set the language of the device operating system



Figure 2-9 Sample of How to Select Languages

After selecting the system language, click **Next** to enter the Wi-Fi connection page, as shown below:

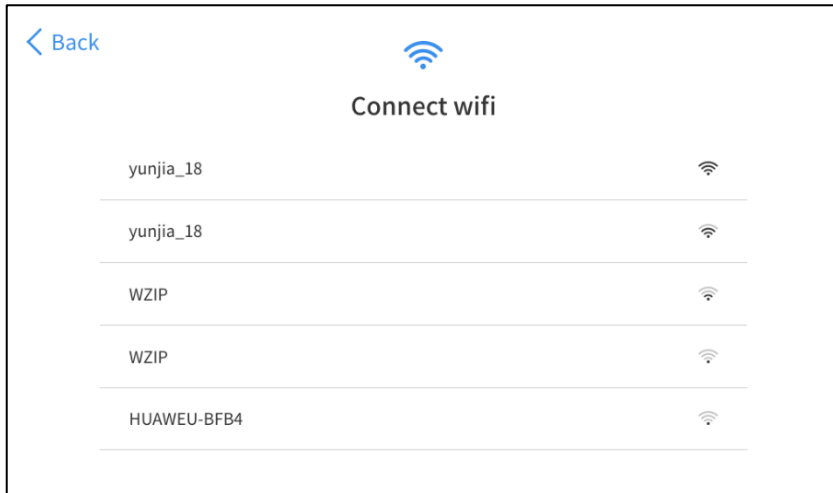

Figure 2-10 Sample of Selecting Wi-Fi

Select a network to connect to on the Wi-Fi connection page.

After a successful network connection, the automatic system will jump to **Factory mode** to download the software:

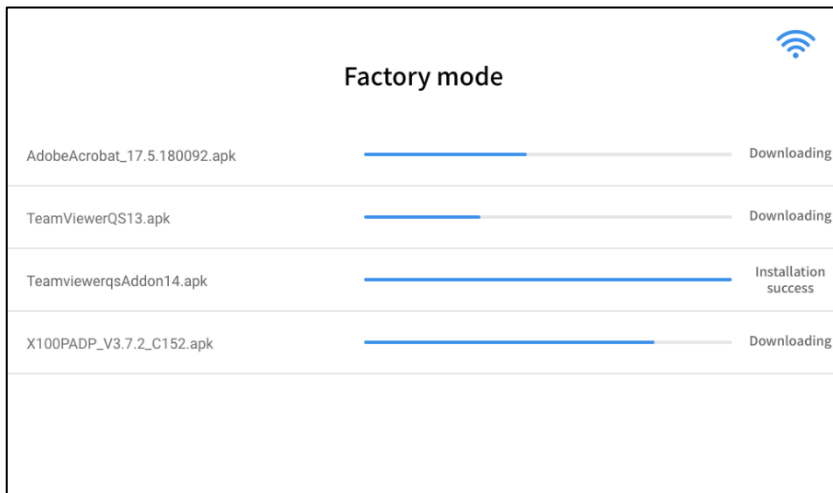

Figure 2-11 Sample of Factory Mode

Once the software has been downloaded, the tablet will automatically reboot and request the system language selection again.

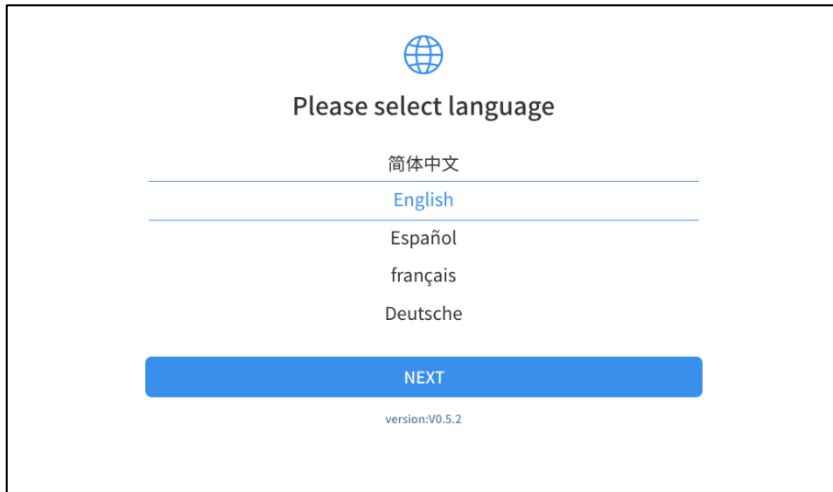

Figure 2-12 Sample of Selecting Languages

After setting the system language, you will enter the activation page, as shown in the figure below. You can also click the "Trial" button in the upper right corner to try it out before activation.

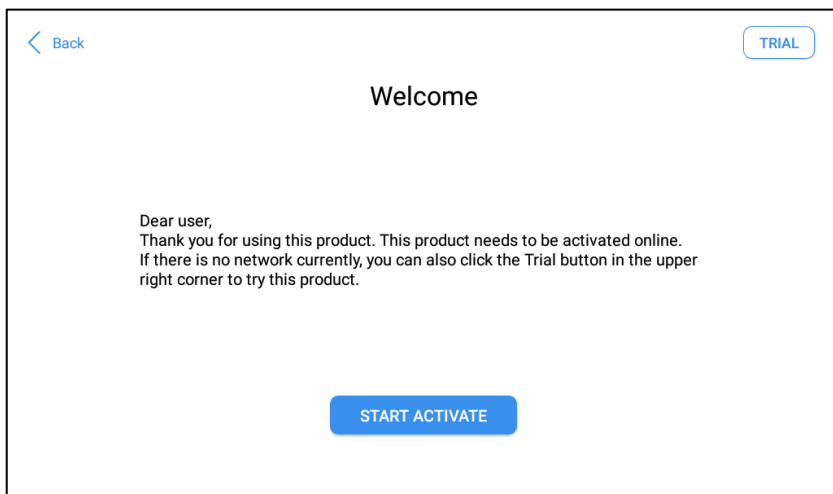

Figure 2-13 Sample of Activation, Screen 1

Click **Start Activate** to enter the activation page, as shown below:

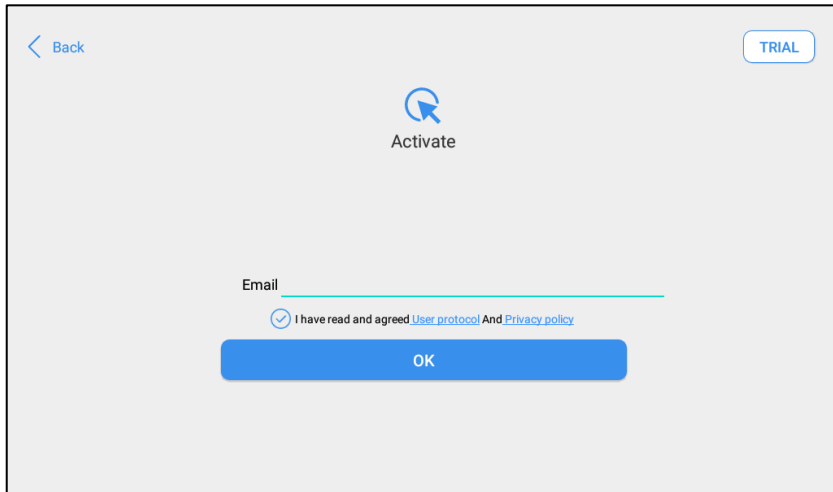

Figure 2-14 Sample of Activation, Screen 2

A pop-up window showing **Activation Success** indicates that you have completed the first boot setup, click **OK** to enter the diagnostic system and start using the device.

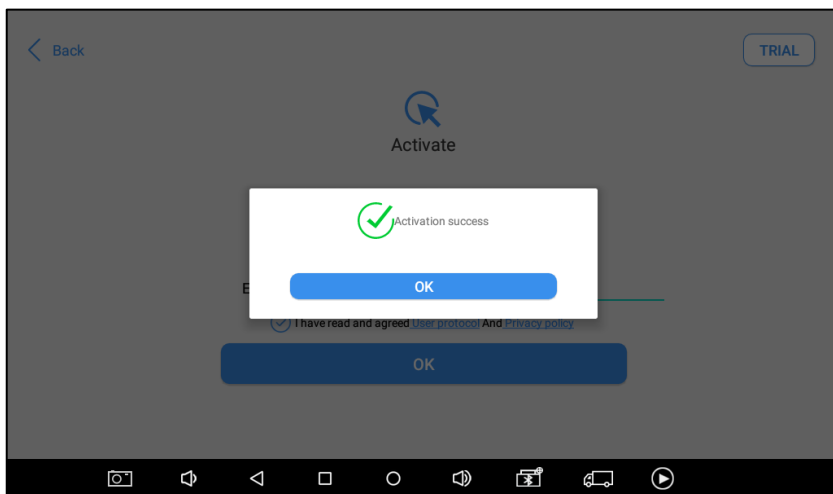

Figure 2-15 Sample of Activation, Screen 3

⚠ If you meet problems like "Registration failed", please check your network or contact Xtool aftersales services: supporting@xtooltech.com

3 UPDATE & DELETE

3.1. UPDATE SOFTWARE

After activating the device, please update the software in "**Update**" first. The device will pull all currently supported software packages from our servers, and you can download them as needed. To access the update application, open the Diagnostics application and click **UPGRADE**, and it will show as below:

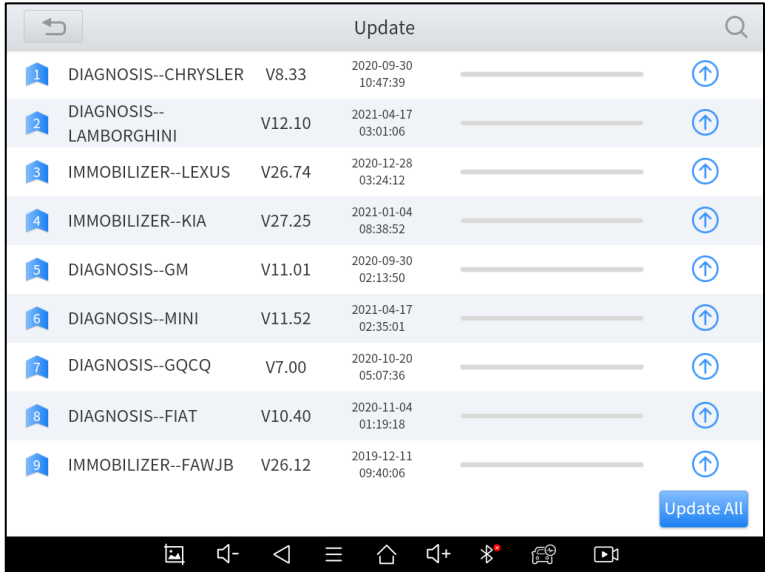

Figure 3-1 Sample of How to Update Vehicle Software

ⓘ D9 Smart Diagnostics System has a three-year free subscription when activated. When you click “update” and it shows “your device is now out of subscription”, please contact your dealer.

3.2. DELETE SOFTWARE

Long-press the unwanted software until it has been selected, then click the **Delete** button shown on the upper part of the screen. And you can select and delete multiple software at once.

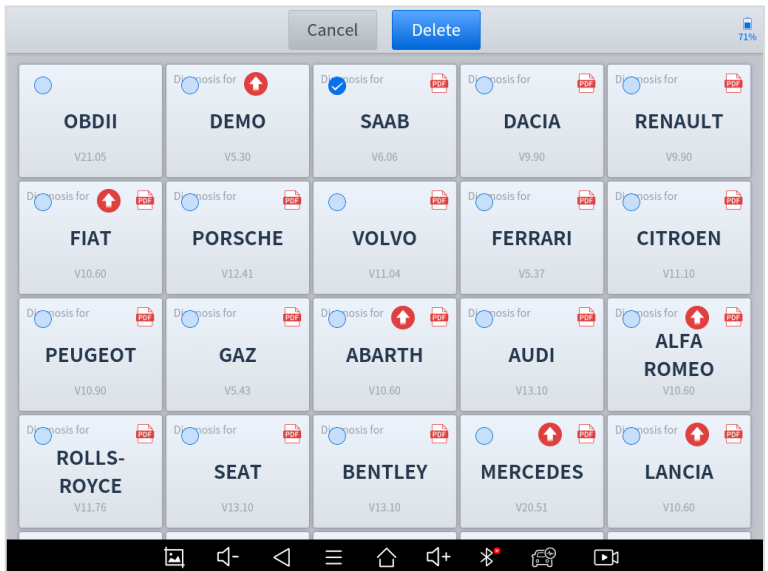

Figure 3-2 Sample of How to Delete Vehicle Software

**** When the device prompts that the memory is insufficient, you can delete the models that are not frequently used to release the memory.**

4 DIAGNOSTICS

The diagnostic application can read ECU information, read and clear DTC and check live data and freeze frames. The Diagnostics application can access the electronic control unit (ECU) of various vehicle control systems, including the engine, transmission, anti-lock braking system (ABS), airbag system (SRS), perform kinds of actuation tests, helping the mechanics and technicians quickly locate and troubleshoot problems.

4.1. VEHICLE CONNECTION

To start the Diagnostics process, the VCI communication box should establish communication with the vehicle.

For D9, it is compatible with both Bluetooth communication and wired communication to connect the tablet and VCI box.

- **Bluetooth Connection**

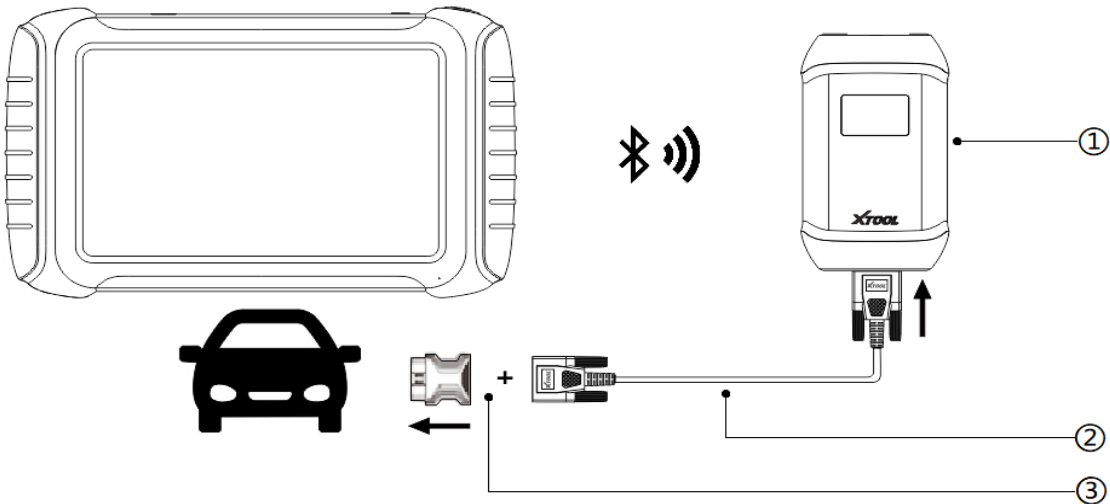

Figure 4-1 Sample of How to Connect Device to Vehicle via Bluetooth

① V204 BOX ;② Main Test Cable; ③ OBD Adapter;

- **Wired Connection**

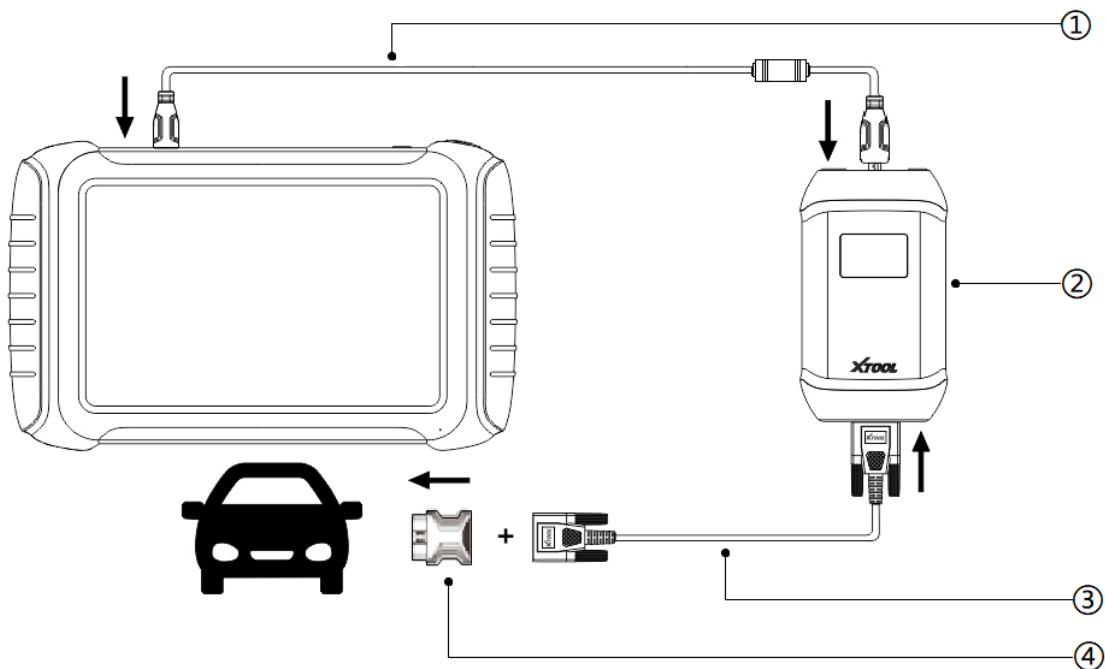

Figure 4-2 Sample of How to Connect Device to Vehicle via Wire

① Data Cable for USB 3.0 to Type B; ② V204 BOX ;③ Main Test Cable; ④ OBD Adapter;

● Please follow the steps below.

1. Turn on the tablet.
2. Connect the vehicle, the VCI box, and the tablet following the diagram below (Figure 4-1 & Figure 4-2). Usually, the OBD port is located under the dashboard, inside the driver's footwell.
3. Wait for the VCI box to communicate with the tablet, then click into the menus to perform the functions.

ⓘ If necessary, please connect the VCI box with the tablet using the USB 3.0 to type-B cable, especially when working on some processes that need to transfer lots of data, like reprogramming ECU.

ⓘ Some older vehicles are not compatible with the OBD II-16 adapter, please make sure you're using the correct adapter. Some extra OBD I connectors are attached to D9 Smart Diagnostics System, please contact your dealer if you need other connectors.

4.2. VEHICLE SELECTION

Click the “**Diagnostics**” icon on the main screen and get into the Diagnostics menu. All brands will be shown on the screen.

Please select the region of your vehicle, click the correct brand, and start the Diagnostics process.

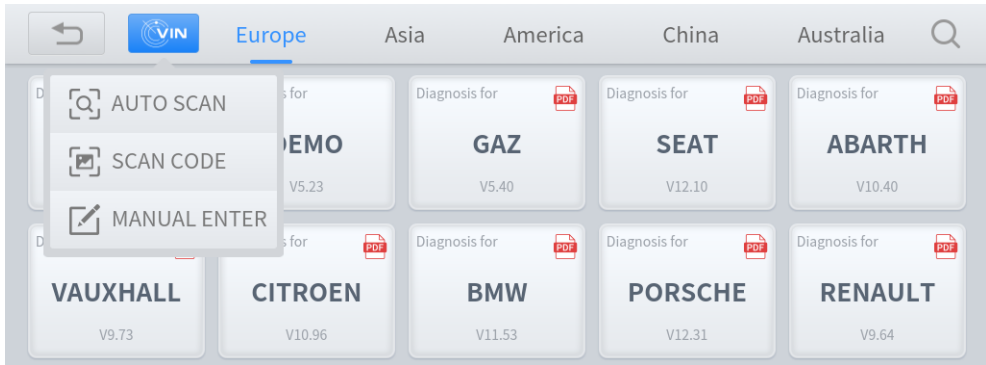

Fig 4-2 Sample of Vin Identification

Click the VIN button in the upper left corner, you can choose to enter the vehicle Diagnostics through the first 3 ways of **AUTO SCAN MANUAL ENTER**.

- **AUTO SCAN**

It supports automatic reading of vehicle VIN code. You also can tap on the button “AUTO SCAN” on the Diagnostics system entrance to use this function.

Please make sure that the car and the device are well connected before using this function.

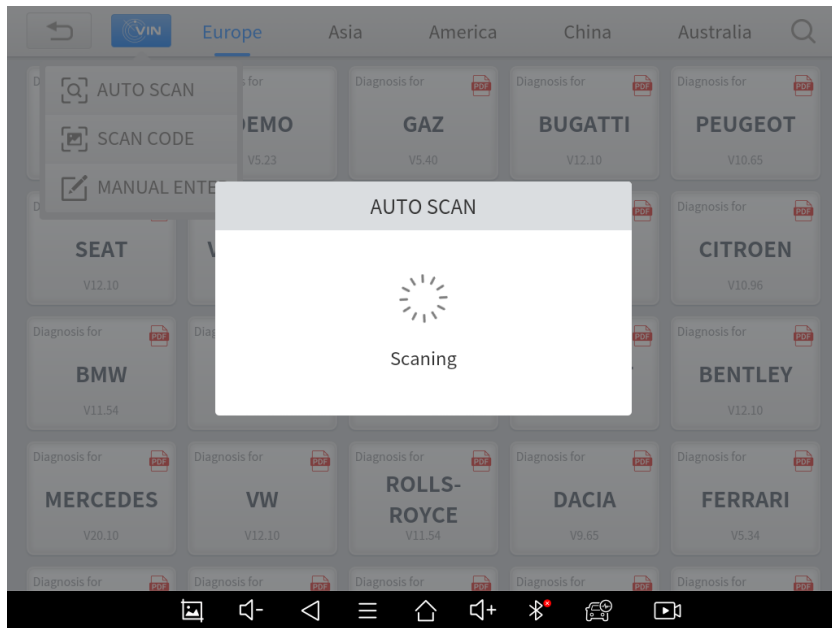

Fig 4-3 Sample of AUTOSCAN

- **MANUAL ENTER**

It supports manual input of car VIN code. When entering the VIN code manually, make sure that the 17 characters entered are correct to avoid reading failure.

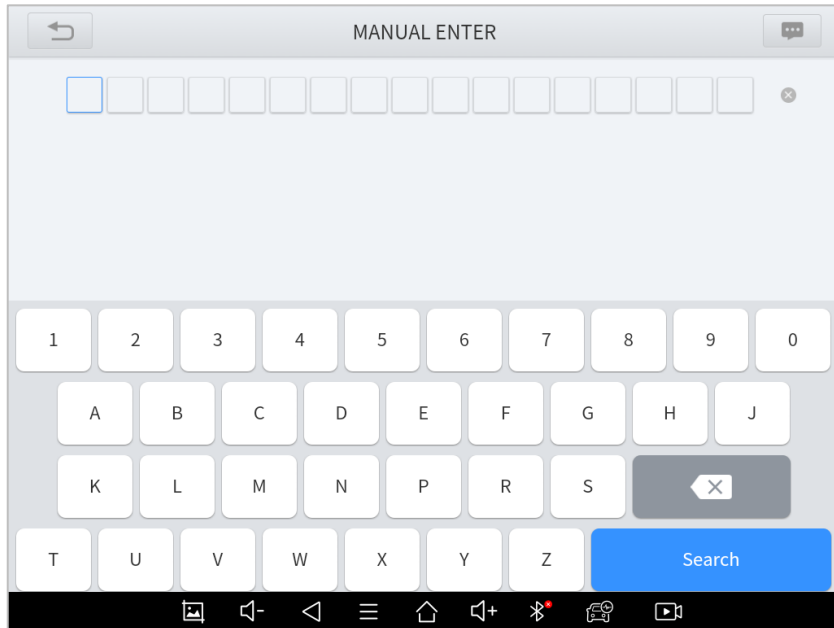

Fig 4-4 Sample of Manually Inputting Vin

- SELECT VEHICLE BY AREA

In addition to the above 2 methods, you can also choose a car brand according to the region. You can select the vehicle model that needs to be diagnosed according to the area, as shown below:

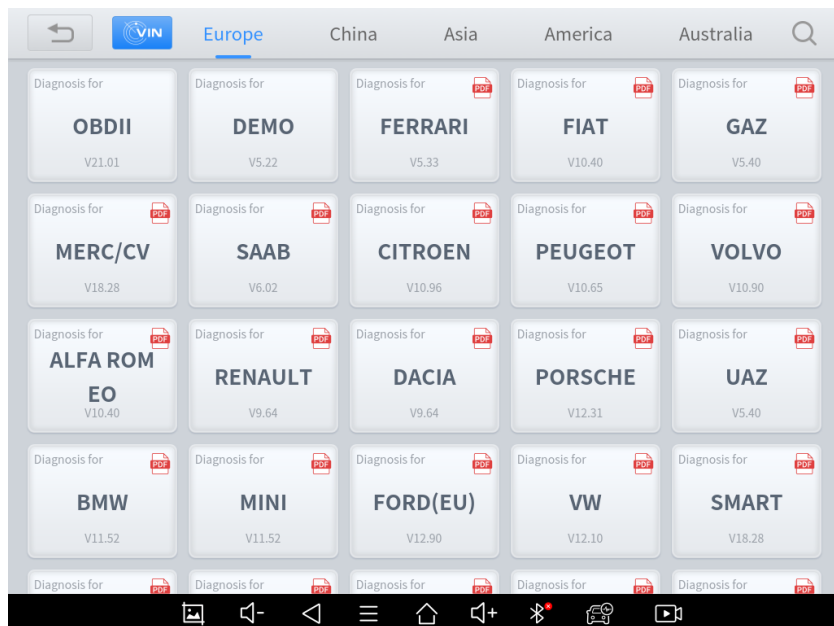

Figure 4-5 Sample of Vehicle Selection by Area

OBD- II supports reading the related fault codes of PCM; DEMO, a demonstration program; Click this button to experience and learn the operation process of the diagnostic function

For some of the vehicle brands (like Volkswagen), when you click on the software, there are several ways to select the model or system you want to run a Diagnostics, including **Automatic Detection**, **Manual Selection**, and **System Selection**.

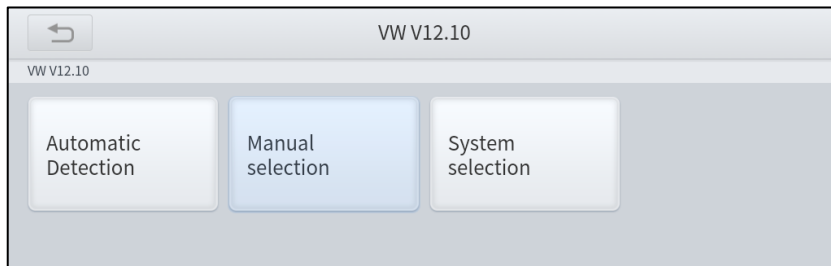

Fig 4-6 Sample of Vehicle Detection Method

Automatic Detection will automatically identify the vehicle's VIN code, and then read the information of your target diagnostic object. If you choose "**Manual selection**", then you can continue to select the vehicle brand, year, and model of the vehicle in the sub-menu to diagnose the vehicle. Enter "**System Selection**", you can also diagnose the vehicle according to the system according to your needs after selecting the model.

① OBDII menu supports reading the common fault codes in the engine. The DTCs may not be the same when compared with using common Diagnostics software.

① DEMO is a demonstration program. You can perform basic Diagnostics functions without connecting to the car.

4.3. DIAGNOSTICS FUNCTIONS

D9 Smart Diagnostics System supports the Diagnostics functions shown below:

- Read ECU Information
- Read/Clear Trouble Code
- Read Live Data
- Actuation Test (Bi-Directional Control)
- Freeze Frame
- Special functions

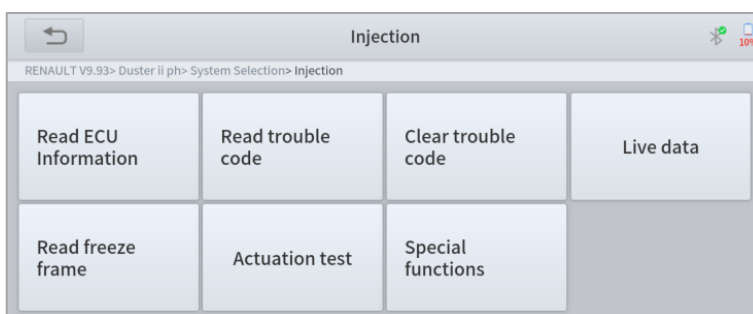

Figure 4-7 Sample of Diagnostics Function

■ Read ECU Information

This function is to read ECU version information, which is the equivalent of "**System Identification**" or "**System information**" in some electronic control systems, which means to read ECU-related software and hardware versions, models, and production date of diesel engine, part number, etc.

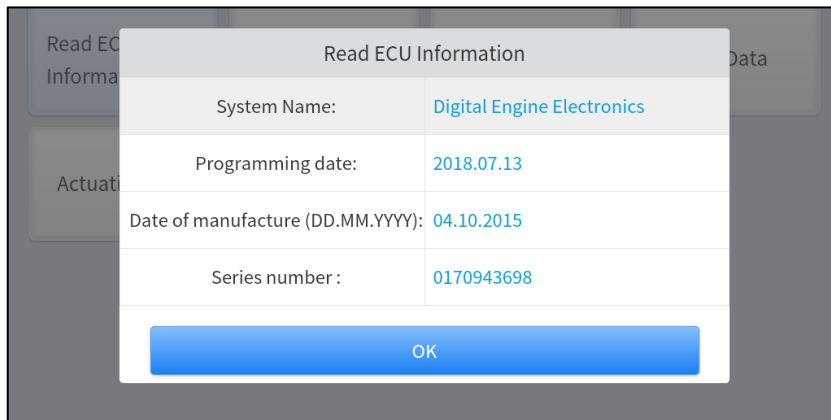

Figure 4-8 Sample of ECU Information

■ Read Trouble Code

Read trouble codes that are stored in ECU. For the fault code, the diagnostic instrument will give specific detailed definitions and explanations to help you locate and eliminate the car fault.

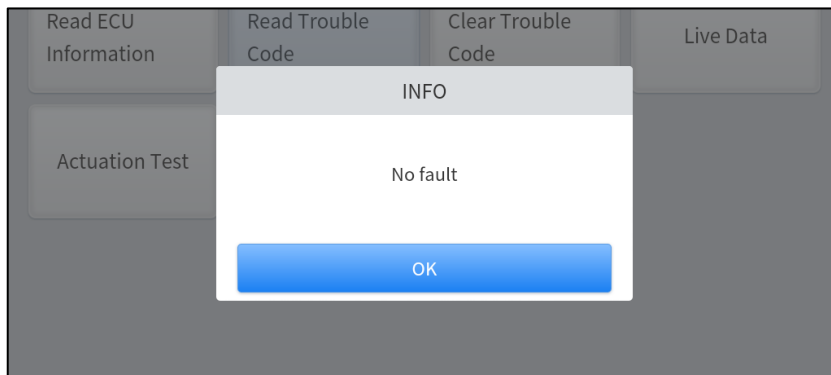

Figure 4-9 Sample of Reading DTC

ⓘ In the process of Diagnostics, if the device shows “System is OK” or “No Trouble Code”, it means there is no related trouble code stored in ECU or some troubles are not under the control of ECU, most of these troubles are mechanical system troubles or executive circuit troubles, it is also possible that signal of the sensor may bias within limits, which can be judged in Live Data.

■ Clear Trouble Code

It allows clearing current and historical trouble codes memory in ECU, under the premise that all the troubles are eliminated. There are two types of fault codes, one is a permanent fault code and the other is a non-permanent fault code. The former requires manual troubleshooting of the car before it can be cleared with a diagnostic tool. Non-permanent fault codes can be cleared directly with the diagnostic tool.

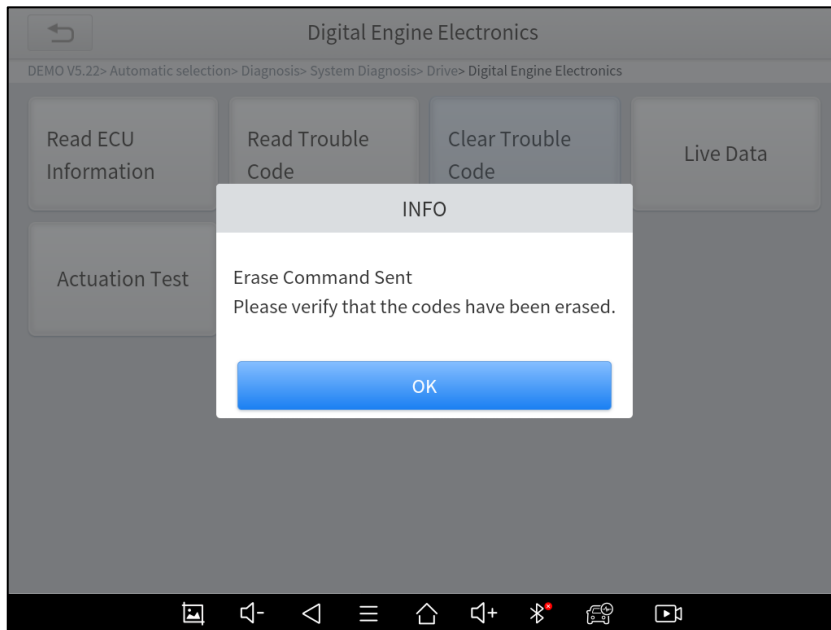

Figure 4-10 Sample of Clear DTC

⚠ The trouble codes can't be erased without eliminating all the troubles, which will cause the diagnostic tool to always read the trouble code because the code will always be saved in ECU.

■ Read Live Data

That is to read the parameters of the running engine, such as oil pressure, temperature, engine speed, fuel oil temperature, coolant temperature, intake air temperature, etc. Based on these parameters, we can judge directly where the problem lies, which helps to narrow the scope of maintenance. For some vehicles, during their actual operation, the problems such as performance characteristics offset, sensitivity reduction, can be judged in live data.

In the process of Diagnostics, if the device shows “**System is OK**” or “**No Trouble Code**”, it means there is no related trouble code stored in ECU or some troubles are not under the control of ECU, most of these troubles are mechanical system troubles or executive circuit troubles, it is also possible that signal of the sensor may bias within limits, which can be judged in Live Data.

Name	Value	Unit
<input type="checkbox"/> Engine speed	6171.75	1/min
<input type="checkbox"/> Coolant temperature	-48.00	degree C
<input type="checkbox"/> Engine oil temperature	3020.25	degree C
<input type="checkbox"/> Emissions warning light: Status	off	
<input type="checkbox"/> Emissions warning light: Distance travelled since activation	N/A	km
<input type="checkbox"/> Status, engine warning light	148	
<input type="checkbox"/> Operating time since engine start	6020.00	s
<input type="checkbox"/> Operating hour counter	3756.00	min

Figure 4-11 Sample of PIDs List

- Click the magnifying glass on the top right, you can search for related PIDs based on keywords

Search Results
Oxygen sensor before catalytic converter: Status ()
Oxygen sensor after catalytic converter: Status ()
Oxygen sensor before catalytic converter, heating: Status ()
Oxygen sensor after catalytic converter, heating: Status ()
Oxygen sensor before catalytic converter: Voltage (V)
Oxygen sensor after catalytic converter: Voltage (V)
Oxygen sensor emissions control: Status ()
Oxygen sensor after catalytic converter: Air ratio value ()
Oxygen sensor before catalytic converter: Air ratio value ()

Figure 4-12 Sample of the PIDs List related by Key Words

■ Custom

Support to show the selected PIDs. Click **Display All**, back to the page which displays all PIDs

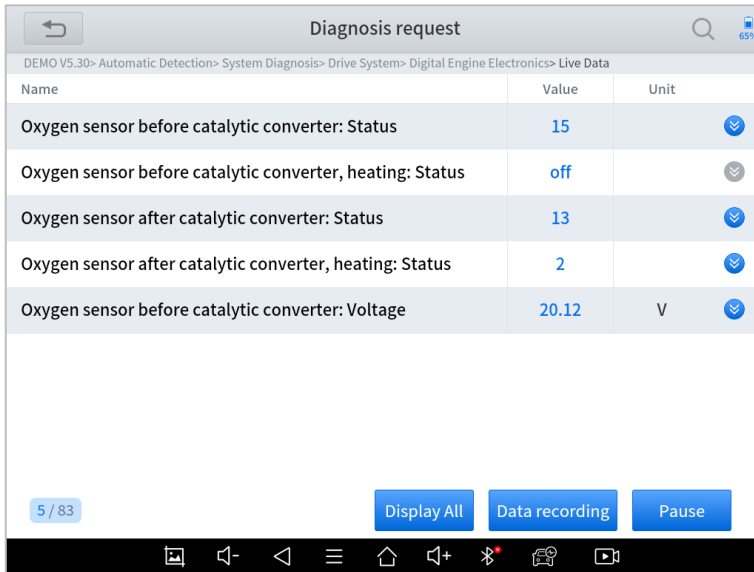

Figure 4-13 Sample of Custom the PIDs

- **Data recording**

Supports recording the current data value in the form of text, you can view the recorded files in **Reports->Data Replay**.

- **Pause**

Click this button to pause the timeline of timeline

- **Combine**

Support to select multiple PIDs and click **Combine** to make different graphs into one chart.

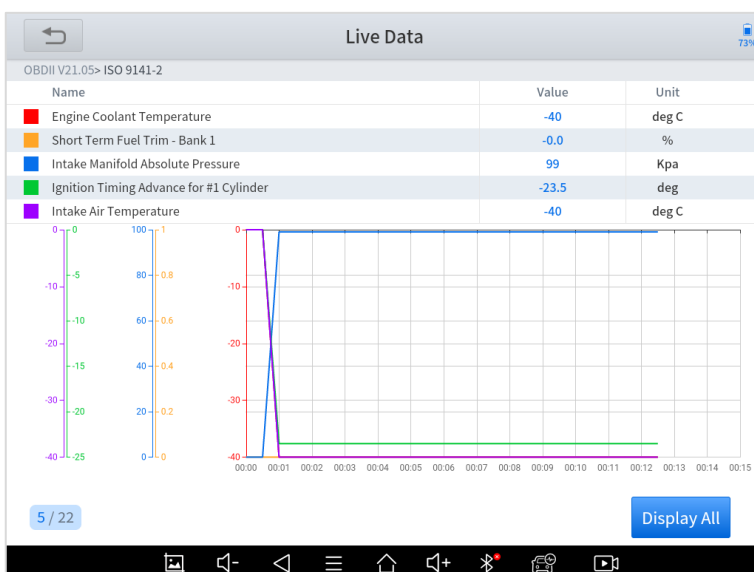

Figure 4-14 Sample of the PIDs Combination

***Note: When customizing the graphs, the number of PIDs selected at a time should not exceed 5**

■ Actuation Test

The actuation test, also known as bidirectional control, is a generic term used to describe sending and receiving information between one device and another.

The vehicle engineers responsible for designing computer control systems programmed them so a scan tool could request information or command a module to perform specific tests and functions. Some manufacturers refer to bidirectional controls as functional tests, actuator tests, inspection tests, system tests, or the like. Reinitialization and reprogramming also can be included in the list of bidirectional controls.

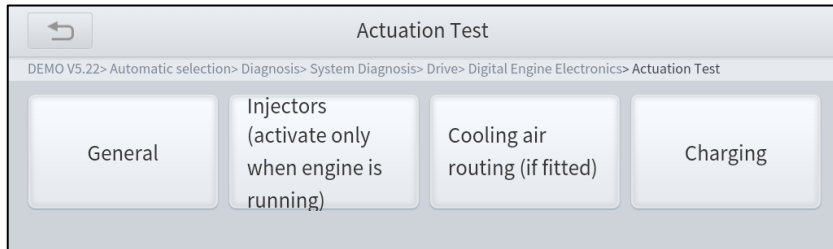

Figure 4-16 Sample of the Actuation Test Menu

This function allows the device to send information to and receive information from, vehicle control modules. For example, in the case of OBD II generic information Mode 1 (which relates to data parameters), the scan tool user initiates a request for information from the powertrain control module (PCM), and the PCM responds by sending the information back to the scan tool for display. Most enhanced scan tools also can actuate relays, injectors, and coils, perform system tests, etc. Users could check the individual part to see what is working properly by actuation test.

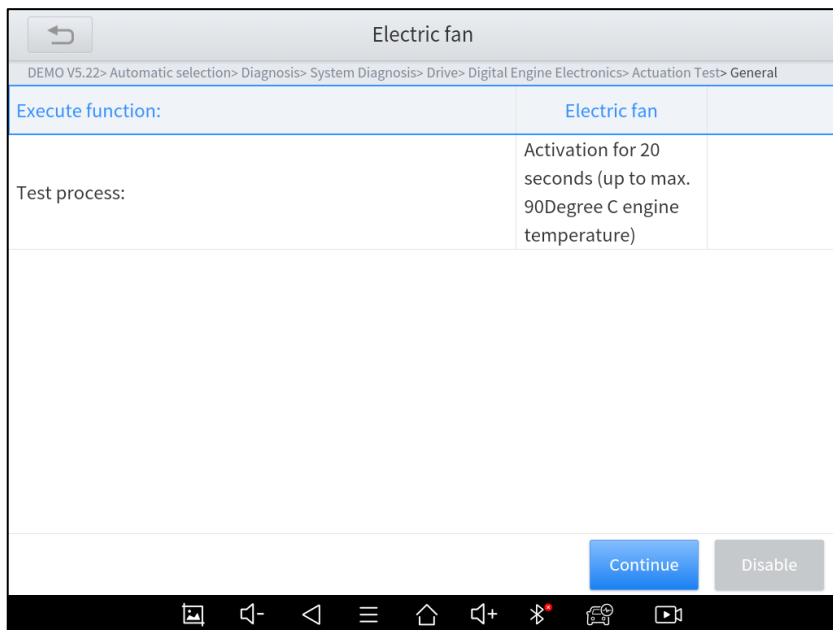

Figure 4-17 Sample of the Actuation Test

■ Freeze Frame

When the signal of the sensor is abnormal, the ECU will save the data at that moment of failure to form a freeze-frame. It is usually used to analyze the reasons that may lead to car failures.

The living data items supported by vehicles of different brands are not the same, so the freeze frames displayed when diagnosing vehicles of different brands may also be different. Some vehicles may not have the option of a freeze-frame which means that the model does not support this function.

Take **Renault Duster ii ph** as an example, after selecting the system to enter the lower freeze frame menu, the device will list all the fault codes under the system.

Users can click on a fault code, such as **DF1068** to view the freeze frame recorded by the car when the fault code occurs, including context when the fault appeared, and current context and additional data.

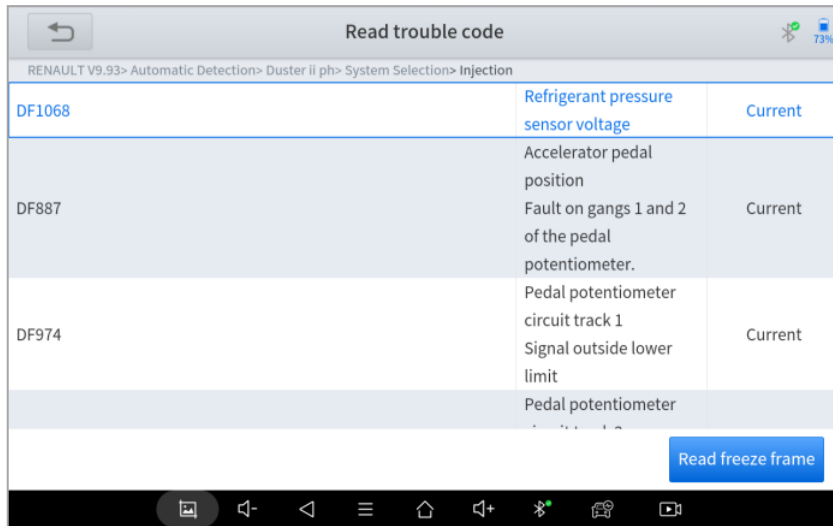

Figure 4-18 Sample of the Freeze frame for Renault Duster ii ph (Screen 1)

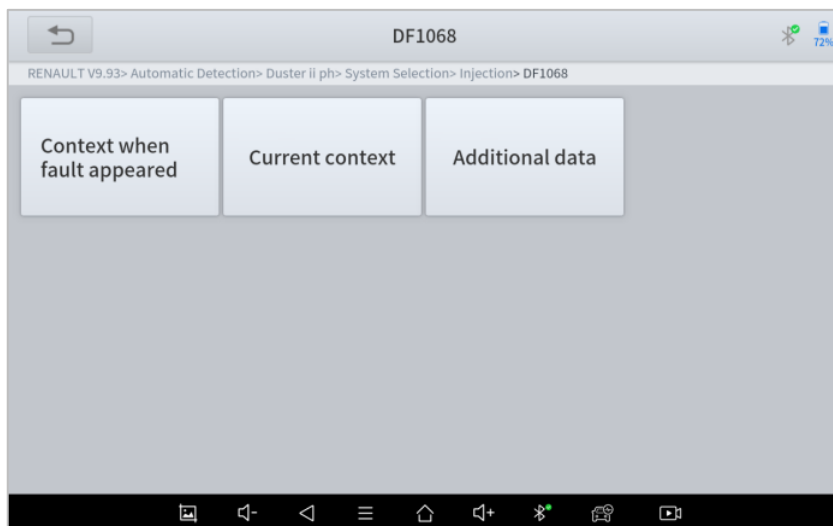

Figure 4-19 Sample of the Freeze frame for Renault Duster ii ph (Screen 2)

Context when fault appeared: record the live data when fault appeared to help the user to know the vehicle status. *Some vehicles don't support this function; users will get a prompt when they click the menu.

Current context: Displays the current live data stream associated with the DTC

NO.	Name	Value	Unit
1	Current context:		
2	Water temperature	-40.0	deg C
3	Computer supply voltage	11.97	V
4	Engine speed	0	rpm
5	Vehicle speed	0.00	km/h
6	Engine torque	0.00	nm
7	Refrigerant pressure	34	bar
8	Refrigerant fluid sensor voltage	-322.68	V

Figure 4-19 Sample of the Freeze frame for Renault Duster ii ph (Screen 3)

Additional data: record other data related to the fault

NO.	Name	Value	Unit
1	Additional data:		
2	Mileage since fault last disappeared		km
3	Mileage since last appearance of fault		km
4	Number of occurrences of fault		
5	Distance when fault first occurred		km
6	Distance travelled with fault present		km

Figure 4-20 Sample of the Freeze frame for Renault Duster ii ph (Screen 4)

■ **Special functions**

Figure 4-21 Sample of the Special Functions for the Injection system of Renault Duster ii ph

Usually, special functions provide various reset or re-learning function menus for most vehicle systems. You can easily and quickly solve some faults through special functions for your car. After some functions are successfully executed, fault codes will be generated, which need to be cleared manually after the car is running for a little while.

And under each system, you can view the special features supported by that system. Different models and systems often have different special functions. Even for the same system of the same model, the years and ECU type may lead to different special functions supported.

5 SPECIAL FUNCTIONS

D9 Smart Diagnostics System also supports 20+ commonly used special reset functions, allowing you to quickly access your vehicle system for various scheduled services, maintenance, and reset performance, eliminating the need to reset after resolving common problems. The special functions interface is shown below:



Figure 5-1 Sample of Special Function

① Due to the limitation of screenshots, the special functions shown in this picture are not complete.

① All special functions supported by the D9 Smart Diagnostics System are subject to the actual special functions displayed on the device.

① Please make sure the vehicle you're working on supports the original functions.

- Below we will introduce the most commonly used service & maintenance functions

5.1. OIL RESET

Reset the Engine Oil Life System, which calculates the optimum oil life change interval based on the vehicle's driving conditions and climate. The oil life reminder must be reset each time the oil is changed so that the system can calculate when the next oil change is required.

This function can be performed in the following cases:

- If the service lamp is on, you must provide service for the car. After service, you need to reset the driving mileage or driving time so that the service lamp turns off and the system enables the new service cycle.
- After changing engine oil or electric appliances that monitor oil life, you need to reset the service lamp.

The operation guidelines of the Oil Reset function are shown below:

1. Enter the **Oil Reset** menu and choose relevant models according to the vehicle being tested.
2. Follow the instructions displayed and press **OK** after completing the instructions shown.

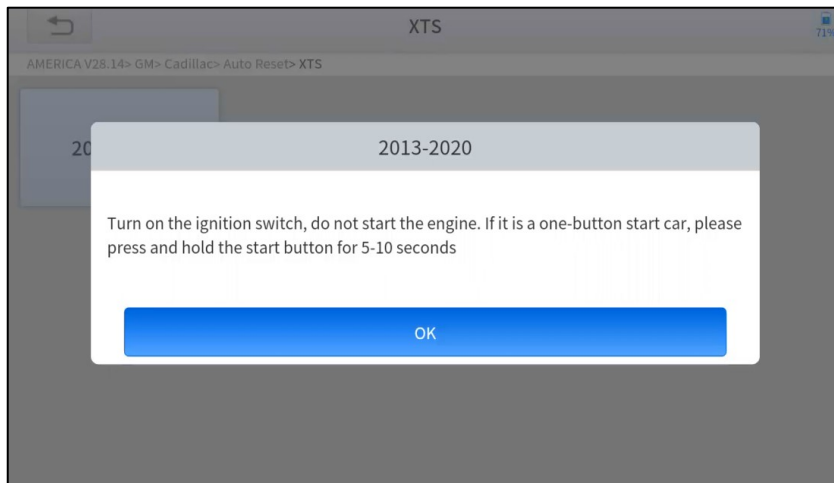

Figure 5-2 Sample of oil reset function (screen 1)

3. Enter the **Maintenance mileage reset** menu.
4. Input reasonable value of mileage and press **OK**.

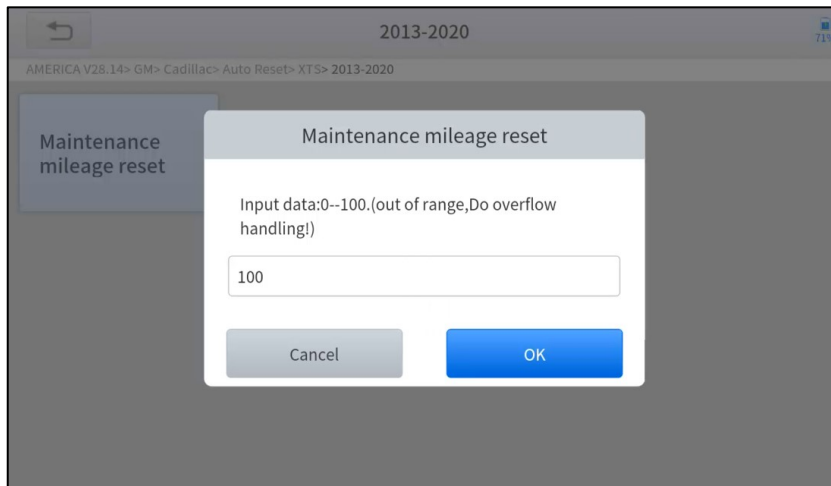

Figure 5-3 Sample of oil reset function (screen 2)

5. Message of [Reset success] displayed when Oil Reset function has successfully performed.

5.2. EPB

Electronic Parking Brake (EPB) System reset is a popular special function. You can use this function to reset the electronic parking brake system and brake pads, which also supports the brake pad replacement (retraction, release of the brake pump), G-sensor, and body angle calibration. This function has multiple uses and can safely and effectively maintain the electronic brake system. These applications include deactivating and activating brake control systems, assisting in controlling brake fluid, opening and closing brake pads, setting brakes after replacing brake discs or brake pads, etc.

1. If the brake pad wears the brake pad sense line, the brake pad sense line will send a signal to the onboard tablet asking for replacing the brake pad. After replacing the brake pad, you must reset the brake pad. Otherwise, the car alarms.
2. Reset must be performed in the following cases:
 - The brake pad and brake pad wear sensor are replaced.
 - The brake pad indicator lamp is on.
 - The brake pad sensor circuit is short, which is recovered.
 - The servo motor is replaced.

The operation guidelines of the EPB function are shown below:

1. Enter the **EPB** menu and choose relevant models according to the vehicle being tested.
2. Follow the instructions displayed and press **YES** after completing the instructions shown.

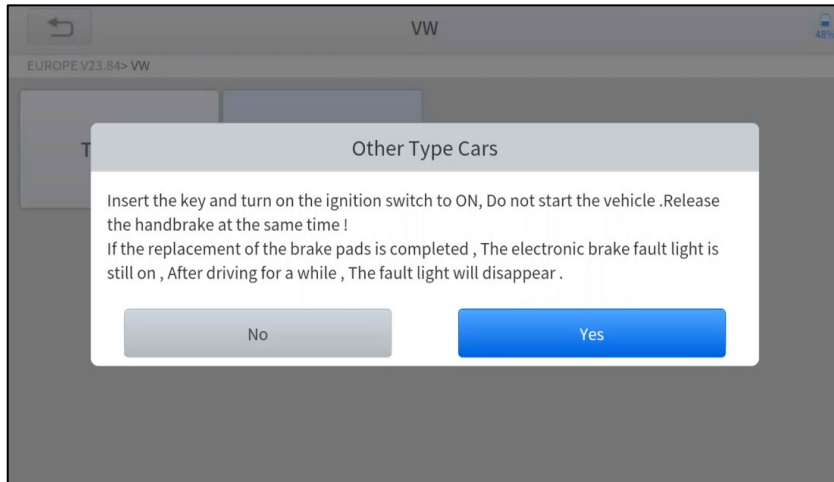

Figure 5-4 Sample of EPB function (screen 1)

3. Enter the **Enter maintenance mode** menu and release the handbrake brake. And press **OK** after completing the instructions shown.

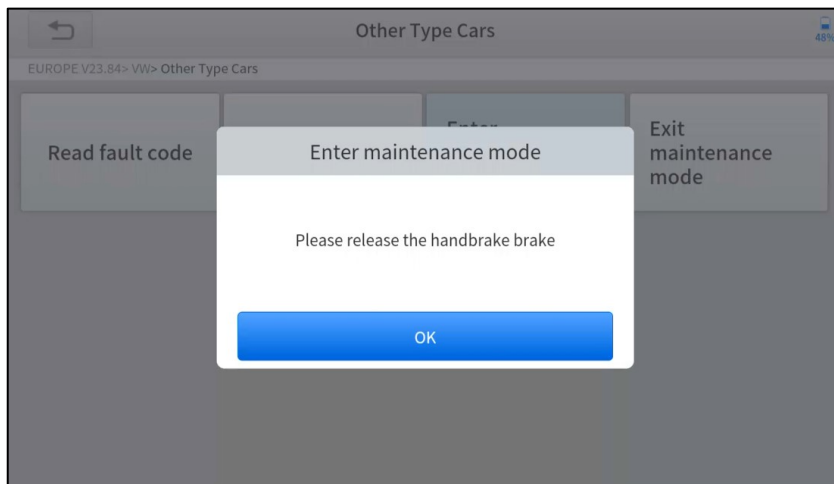

Figure 5-5 Sample of EPB function (screen 2)

4. Wait until the message '**Successful operation**' pops up. And press **OK** to exit the menu.
5. Enter the **Exit maintenance mode** menu and wait until the message of "**Successful operation**' popes up.

5.3. SAS

Steering Angle Sensors (SAS) System Calibration permanently stores the current steering wheel position as the straight-ahead position in the SAS EEPROM. Therefore, the front wheels and the steering wheel must be set exactly to the straight-ahead position before calibration. In addition, the VIN is also read from the instrument cluster and stored permanently in the SAS EEPROM. On successful completion of calibration, the SAS fault codes will be automatically cleared.

To reset the steering angle, you need to first find the relative zero point position for the car to drive in a straight line. Taking this position as a reference, the ECU can calculate the accurate angle for left and right steering.

After replacing the steering angle position sensor, replacing steering mechanical parts (such as steering gearbox, steering column, end tie rod, steering knuckle), performing four-wheel alignment, or recovering the car body, you must reset the steering angle.

The operation guidelines of the SAS function are shown below:

1. Enter the **SAS** menu and choose relevant models according to the vehicle being tested.
2. Enter the **Set steering angle sensor** menu and follow the instructions displayed.

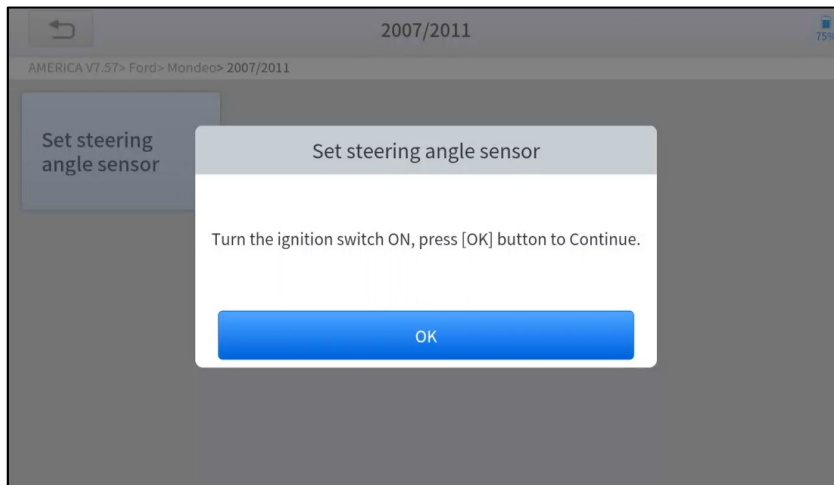

Figure 5-6 Sample of SAS function (screen 1)

3. Wait until the following instruction is displayed and press **Yes** after completing the instructions shown.

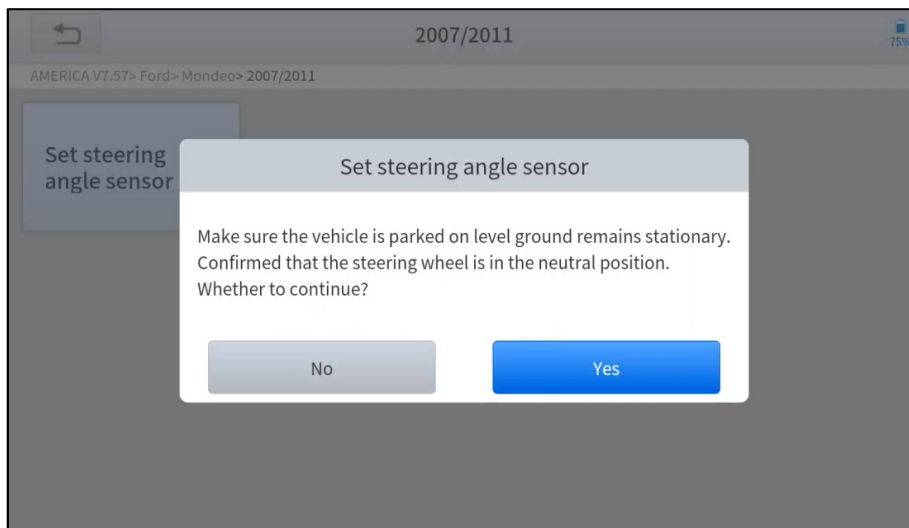

Figure 5-7 Sample of SAS function (screen 2)

4. Follow the instructions displayed and press **OK** after completing the instructions shown.

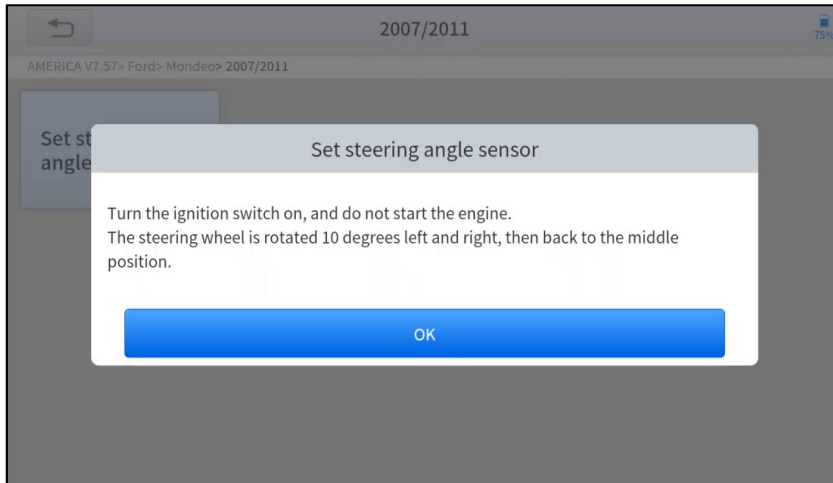

Figure 5-8 Sample of SAS function (screen 3)

5. Wait until the following instruction is displayed and press **OK** after completing the instructions shown.

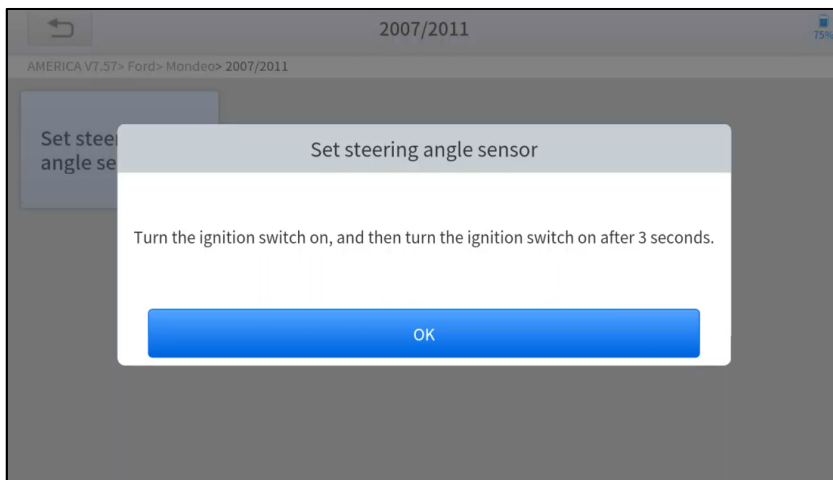

Figure 5-9 Sample of SAS function (screen 4)

6. Message of '**Function execution is completed**' displayed when SAS function has successfully performed.

5.4. DPF

The Diesel Particle Filter (DPF) function manages DPF regeneration, DPF component replacement teach-in, and DPF teach-in after replacing the engine control module (ECM).

The ECM monitors driving style and selects a suitable time to employ regeneration. Vehicles driven a lot at idling speed and low load will attempt to regenerate earlier than vehicles driven more with higher load and speed. For regeneration to take place, a prolonged high exhaust temperature must be obtained.

In the event of the car being driven in such ways that regeneration is not possible, i.e., frequent short journeys, a diagnostic trouble code will eventually be registered in addition to the DPF light and “Check Engine” indicators displaying. A service regeneration can be requested in the workshop using the diagnostic tool.

DPF regeneration is used to clear PM (Particulate Matter) from the DPF filter through continuous combustion oxidation mode (such as high-temperature heating combustion, fuel additive, or catalyst to reduce PM ignition combustion) to stabilize the filter performance.

DPF regeneration may be performed in the following cases:

- The exhaust back pressure sensor is replaced.
- The PM trap is removed or replaced.
- The fuel additive nozzle is removed or replaced.
- The catalytic oxidizer is removed or replaced.
- The DPF regeneration MIL is on and maintenance is performed.
- The DPF regeneration control module is replaced.

The operation guidelines of the DPF function are shown below:

1. Enter the **DPF** menu and choose relevant models according to the vehicle being tested.
2. Enter the **DPF regeneration** menu.
3. Read carefully and complete the **requisites** listed before performing the DPF regeneration function. And press **OK** after completing the instructions shown.

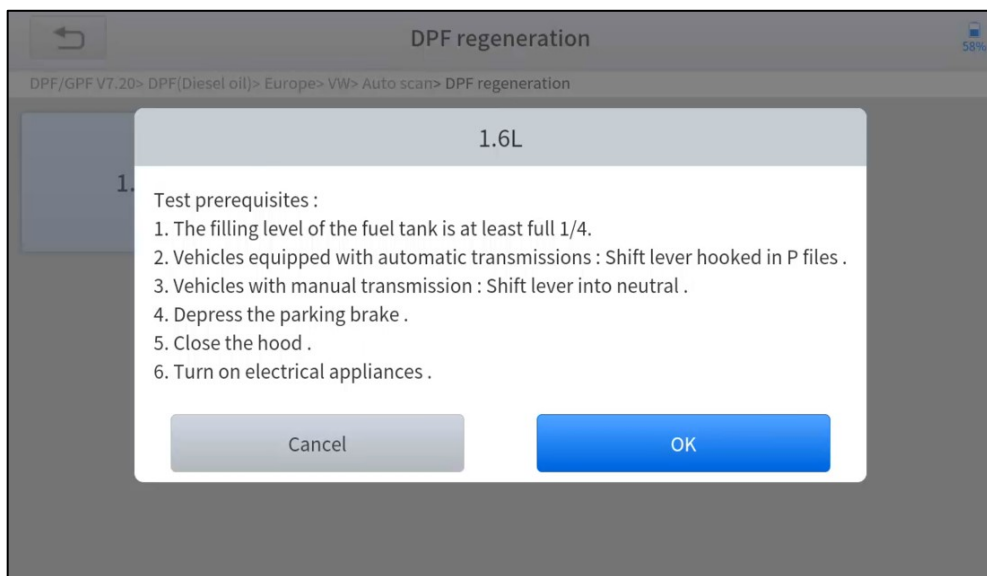

Figure 5-10 Sample of DPF function (screen 1)

4. Read the fuel tank level and make sure that it fulfills the requirement displayed.
5. Read the carbon deposit load.
6. Choose the drive to warm up and follow the instructions listed below. And press OK after completing the instructions shown.

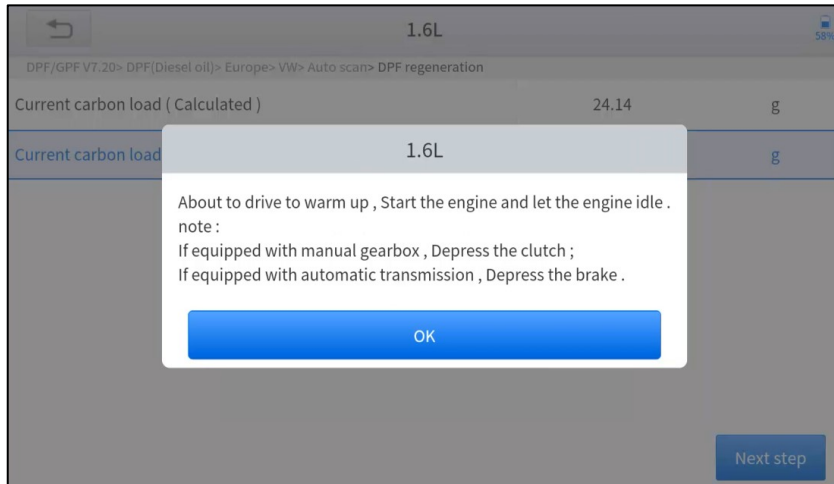

Figure 5-11 Sample of DPF function (screen 2)

7. Read the note carefully and follow the instructions shown on the screen. And press **OK** after completing the instructions shown.

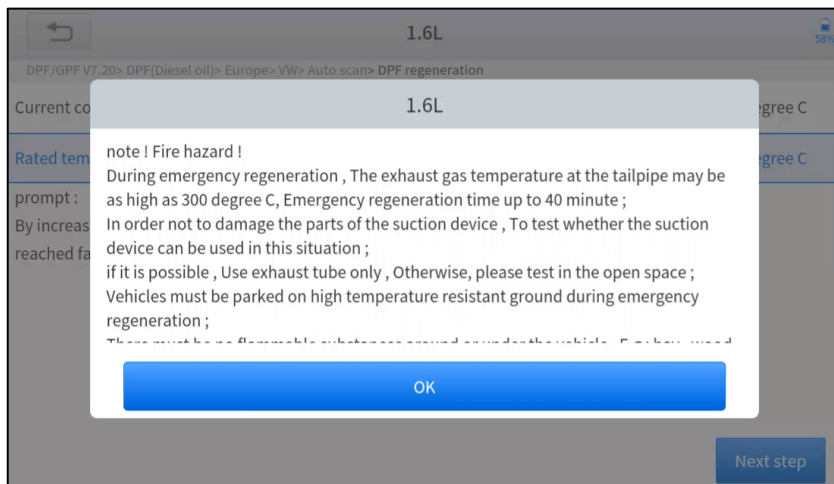

Figure 5-12 Sample of DPF function (screen 3)

8. Follow the instructions displayed and press **OK** after completing the instructions shown. Please pay attention to the Note.

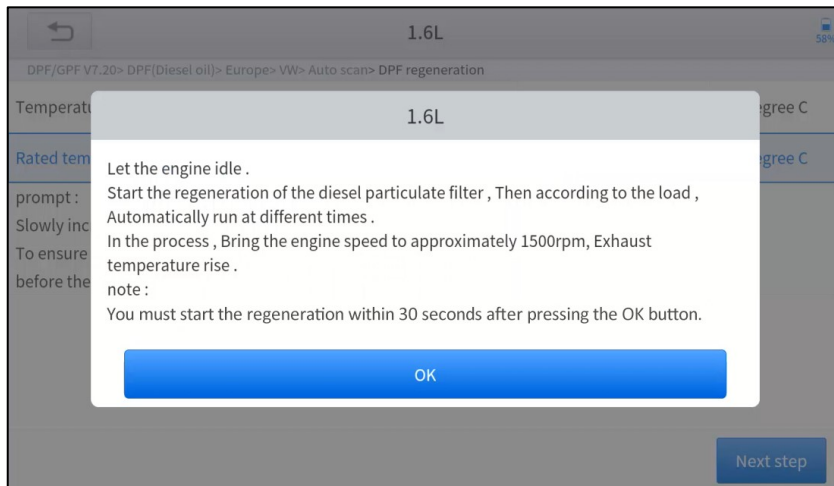

Figure 5-13 Sample of DPF function (screen 4)

9. Press the **OK** button to start the regeneration.

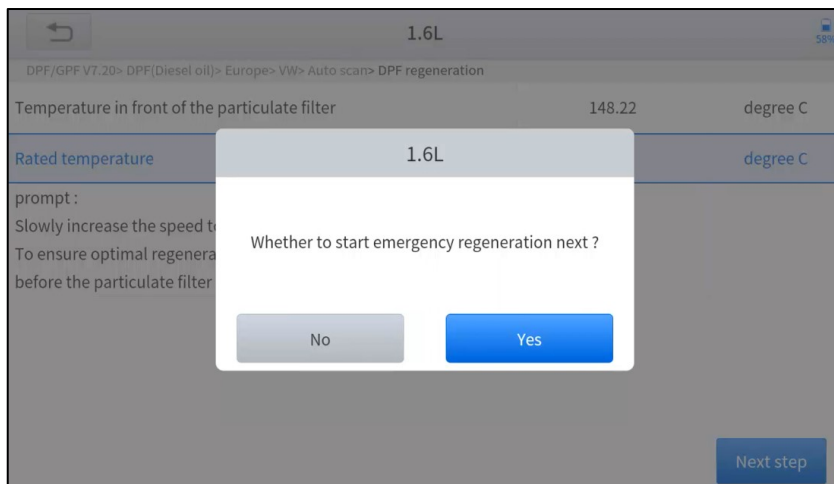

Figure 5-14 Sample of DPF function (screen 5)

10. Wait for the value of the carbon deposit to decrease until a message of 'Emergency regeneration has been **completed**' pops up, this process may take up to 40 minutes.

1.6L		
DPF/GPF V7.20> DPF(Diesel oil)> Europe> VW> Auto scan> DPF regeneration		
Regeneration duration	0.00	min
Carbon deposit	22.78	g
Rotating speed	781	rpm
Waste temperature upstream of turbocharger	143.41	degree C
Upstream of particulate filter	143.21	degree C
Downstream of particulate filter	112.38	degree C
Next step		

Figure 5-15 Sample of DPF function (screen 5)

11. Wait for **2 minutes** to let the particulate filter cool down.

1.6L		
DPF/GPF V7.20> DPF(Diesel oil)> Europe> VW> Auto scan> DPF regeneration		
Current carbon load (Calculated)	24.14	g
Current carbon load (Measurements)	1.32	g
Let the engine run at idle again 2 Minutes to cool down the hot particulate filter	120	s
drop out		

Figure 5-16 Sample of DPF function (screen 6)

12. Press **drop out** to exit the DPF function.

5.5. BMS RESET

The Battery Management System (BMS) allows the scan tool to evaluate the battery charge state, monitor the close-circuit current, register the battery replacement, and activate the rest state of the vehicle.

This function enables you to perform a resetting operation on the monitoring unit of the vehicle battery, in which the original low battery fault information will be cleared and battery matching will be done.

Battery matching must be performed in the following cases:

- The main battery is replaced. Battery matching must be performed to clear original low battery information and prevent the related control module from detecting false information. If the related control module

detects false information, it will invalidate some electric auxiliary functions, such as automatic start & stop function, sunroof without one-key trigger function, power window without automatic function.

- Battery matching is performed to re-match the control module and motoring sensor to detect battery power usage more accurately, which can avoid an error message displayed on the instrument cluster.

The operation guidelines of the BMS Reset function are shown below:

1. Enter the **BMS Reset** menu and choose relevant models according to the vehicle being tested.
2. Turn on the ignition switch.
3. Press **OK** to continue the BMS function.
4. Enter **battery capacity** (within the given range) and press **OK** after the input.

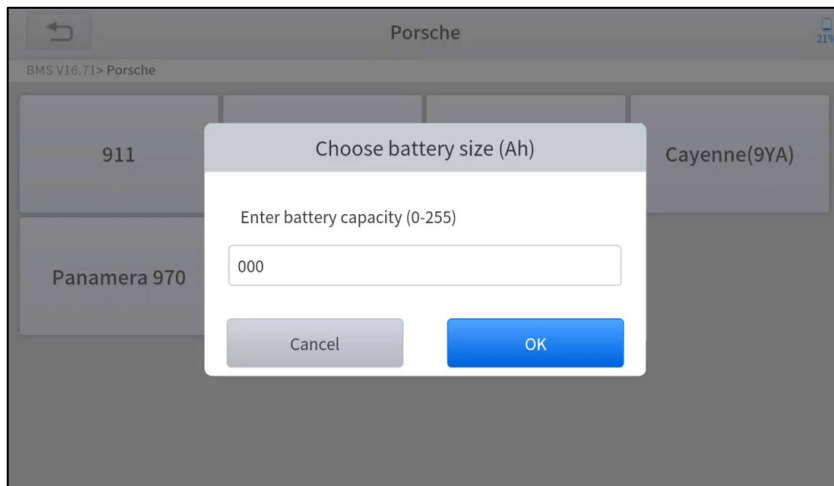

Figure 5-17 Sample of BMS function (screen 1)

5. Enter the **battery manufacturer** and press **OK** after the input.

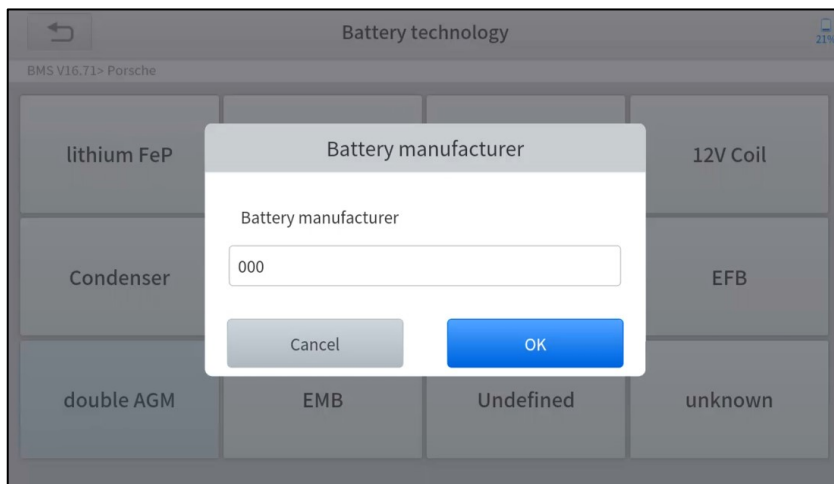

Figure 5-18 Sample of BMS function (screen 2)

6. Enter the **10-digit battery serial number** and press **OK** after the input.

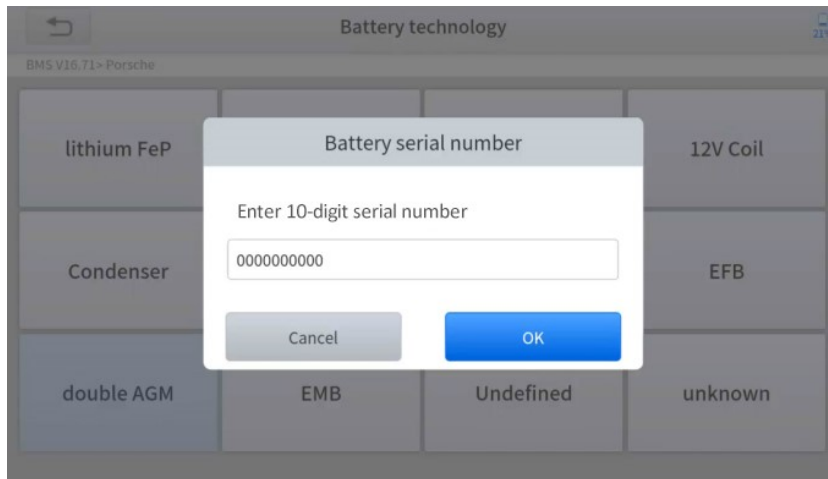

Figure 5-19 Sample of BMS function (screen 3)

5.6. THROTTLE

Throttle Position Sensor (TPS) Match, this function enables you to make initial settings to throttle actuators and returns the “learned” values stored on ECU to the default state. Doing so can accurately control the actions of regulating throttle (or idle engine) to adjust the amount of air intake.

The operation guidelines of the Throttle function are shown below:

1. Enter the **Throttle** menu and choose relevant models according to the vehicle being tested.
2. Enter the **Auto Recognition** menu and turn on the ignition switch.
3. Read carefully and complete the **requisites** listed before performing the throttle regeneration function. And press **OK** after completing the instructions shown.

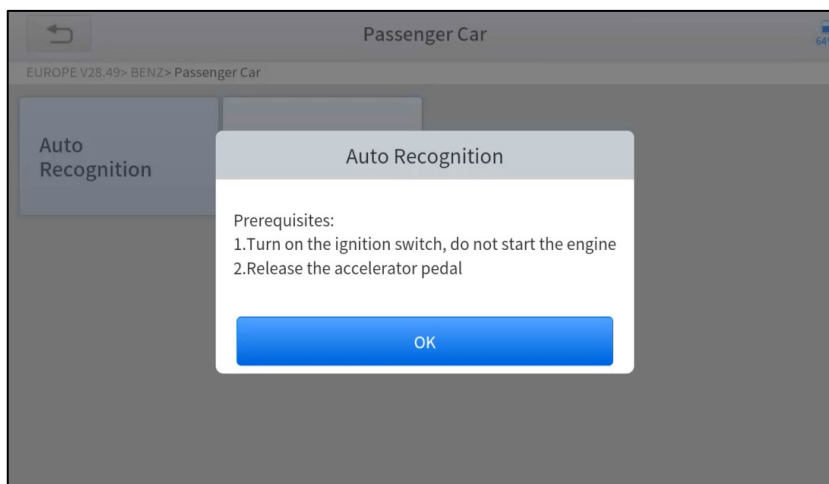

Figure 5-20 Sample of throttle function (screen 1)

4. Wait until all the parameters are read and displayed.

Auto Recognition		
EUROPE V28.49> BENZ> Passenger Car		
Engine speed(rpm)	0	<= 10
Coolant temperature(deg C)	48.00	5.00-100.00
Intake air temperature(deg C)	12.00	<= 40
Accelerator pedal position(%)	0.39	<= 5
Throttle regulator	Already learned	Status
F1:Exit F2:Match the throttle limit position		
		<input type="button" value="F1"/> <input type="button" value="F2"/>

Figure 5-21 Sample of throttle function (screen 2)

- Press the **F2** button and wait until a message of **'Match successfully'** pops up.

5.7. INJECTOR CODING

This function can write the identification code of the fuel injector into the ECU so that the ECU can recognize and work normally. Write actual injector code or rewrite code in the ECU to the injector code of the corresponding cylinder for controlling accurately and correcting cylinder injection quantity.

After the ECU or injector is replaced, the injector code of each cylinder must be confirmed or re-coded so that the cylinder can better identify injectors to accurately control fuel injection.

ⓘ In general cases, there is no need to do the coding matching function after cleaning.

ⓘ The identification of the fuel injector includes its working accuracy value and type value. When replacing it, you need to find the corresponding model for replacement.

ⓘ At present, mainstream cars support injector coding functions.

The operation guidelines of the Injector Coding function are shown below:

- Enter the **Injector coding** menu and choose relevant chassis models according to the vehicle being tested.
- Enter the **Fuel injection nozzle injection volume adjustment** menu.

Read the note displayed carefully and press **OK** after the reading.

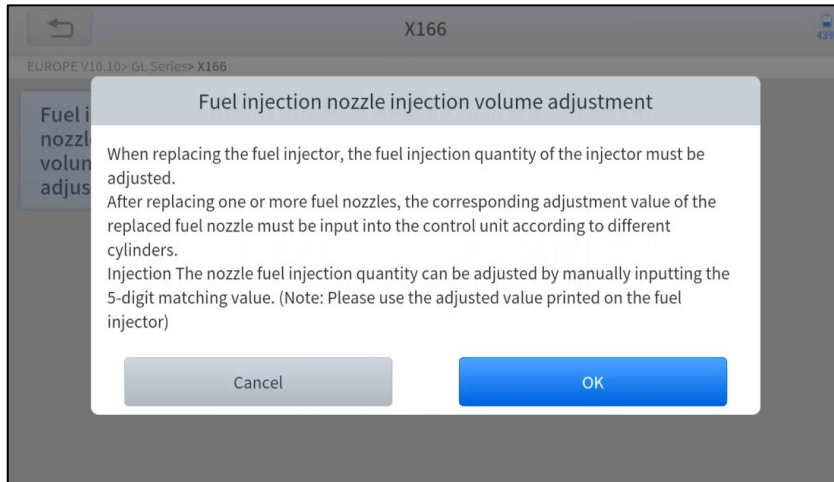

Figure 5-22 Sample of injector coding function (screen 1)

3. Read and confirm the value stored in the cylinders.

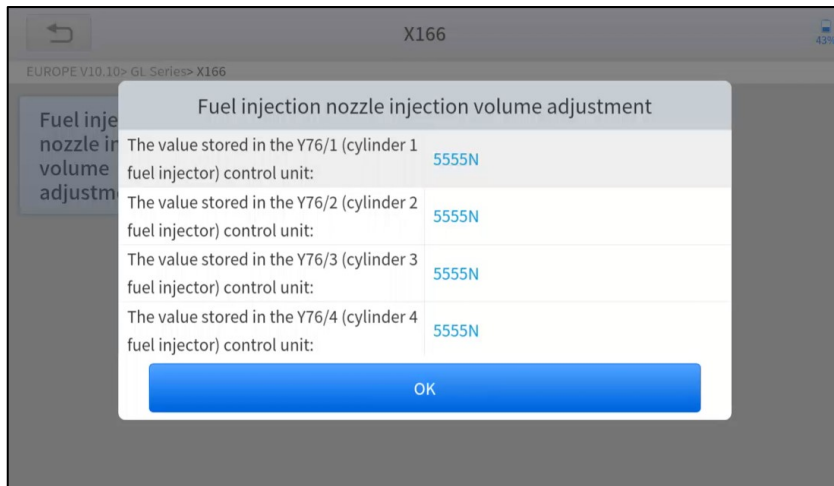

Figure 5-23 Sample of injector coding function (screen 2)

4. Enter the **Change the value of cylinder** menu of the replaced injector(s), enter the **new 5-digit value**, and then press **OK**.

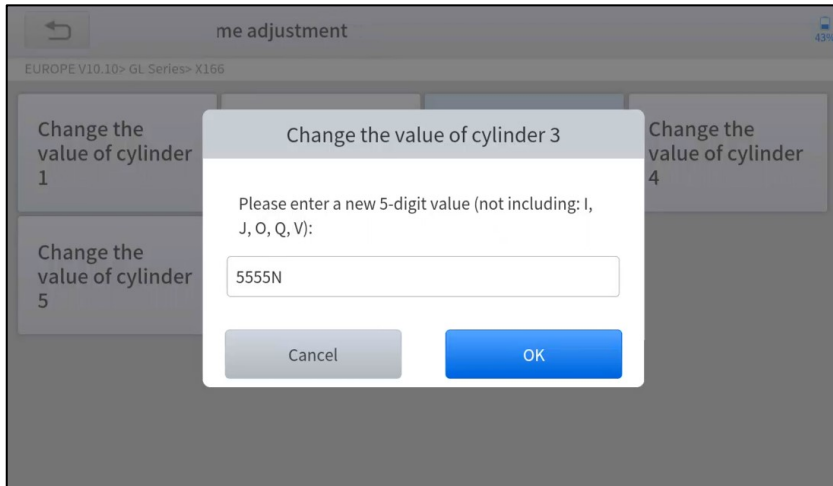

Figure 5-24 Sample of injector coding function (screen 3)

5. Wait until the message '**Write successfully**' pops up.
6. Turn off the ignition switch.
7. Wait until the message asked you to turn on the ignition switch.
8. Re-enter the **Fuel injection nozzle injection volume adjustment** menu to check whether the new value(s) are shown.

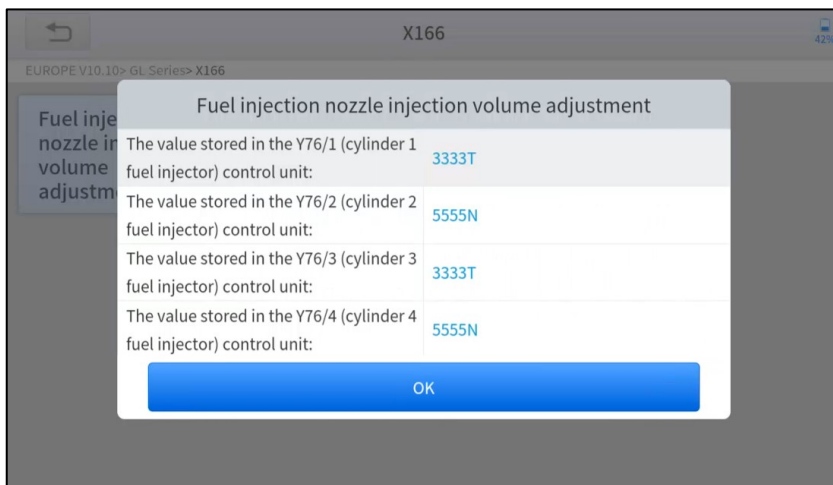

Figure 5-25 Sample of injector coding function (screen 4)

5.8. GEARBOX MATCH

After changing the gearbox or changing the gearbox ECU, you need to use the gearbox matching function to re-match the engine and the gearbox.

ⓘ Before resetting the gearbox, please check the gearbox control unit to ensure that there is no fault code. If there is a fault code, the gearbox memory function cannot be reset. Please road test after reset.

The operation guidelines of the Gearbox Matching function are shown below:

1. Enter the **Gearbox matching** menu and choose relevant models according to the vehicle being tested.
2. Enter the **Reset adaptive value** menu.
3. Turn on the ignition without starting the engine.
4. Read the note and press **OK** to continue the Gearbox Matching function.

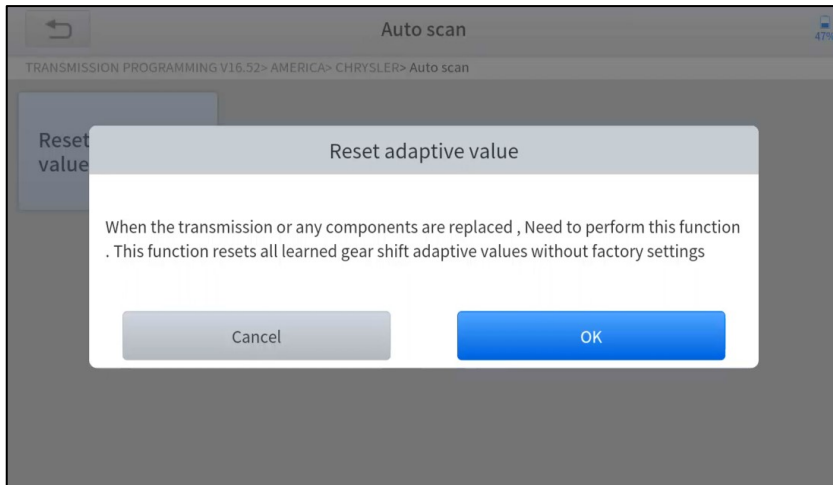

Figure 5-26 Sample of gearbox matching function (screen 1)

5. Wait until the message '**Successful operation**' pops up.

5.9. GEAR LEARNING

The crankshaft position sensor learns crankshaft tooth machining tolerance and saves to the tablet to more accurately diagnose engine misfires. If gear learning is not performed for a car equipped with a Delphi engine, the MIL turns on after the engine is started. The diagnostic device detects the DTC P1336 'Gear not learned'. In this case, you must use the diagnostic device to perform gear learning for the car. After gear learning is successful, the MIL turns off. This function can complete the self-learning of the gearbox and improve the quality of shifting.

After the engine ECU, crankshaft position sensor, or crankshaft flywheel is replaced, or the DTC 'gear not learned' is present, gear learning must be performed.

The operation guidelines of the Gear learning function are shown below:

1. Enter the **Gear learning** menu and choose relevant models according to the vehicle being tested.
2. Turn on the ignition switch to start the vehicle.
3. Enter the **Tooth Learning** menu.

Read carefully and complete the **requisites** listed before performing the gear learning function. And press **OK** after completing the instructions shown

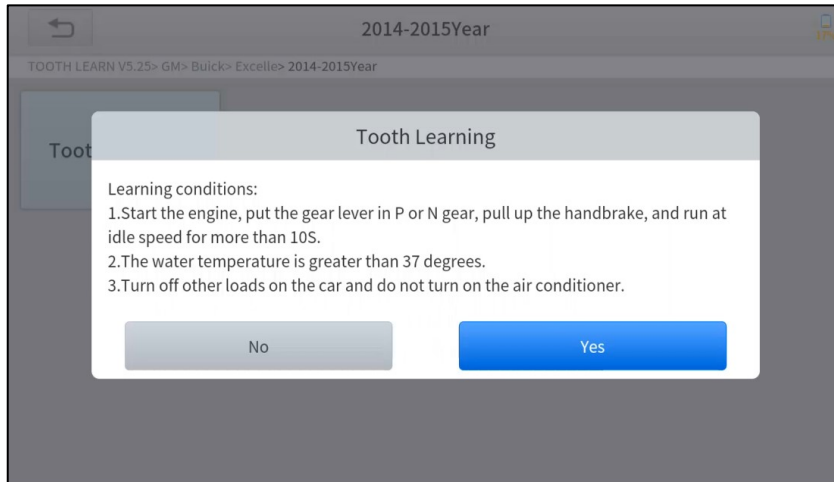

Figure 5-27 Sample of gear learning function (screen 1)

4. Read the instructions displayed and press **Yes** to start the learning process.

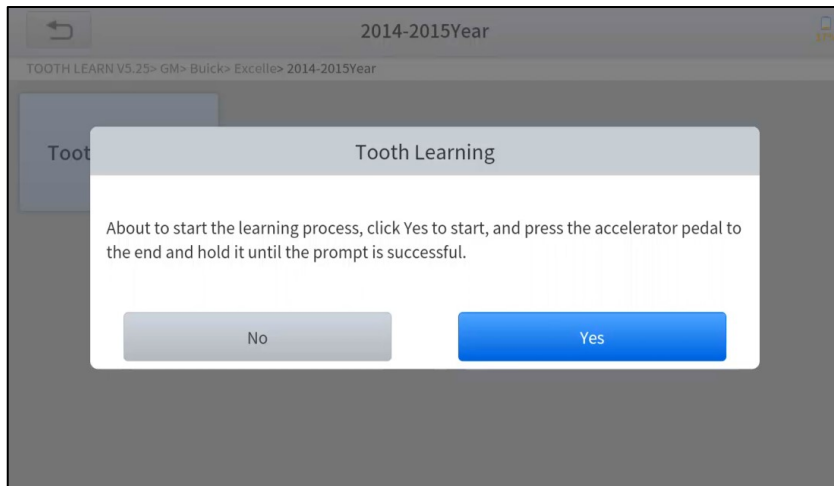

Figure 5-28 Sample of gear learning function (screen 2)

5. **Press the accelerator pedal** down and hold it until a message of 'The **learning is successful**, please release the accelerator pedal.' pops up.
6. Release the accelerator pedal and press **OK** to exit the gear learning function.

6 REPORT

A diagnostic Report is used for viewing and printing the saved files, such as Live Data, Trouble Codes, or pictures generated in the process of Diagnostics, users also can view a record of which cars have been previously tested. It includes 3 parts:

- Report
- Replay
- File Management

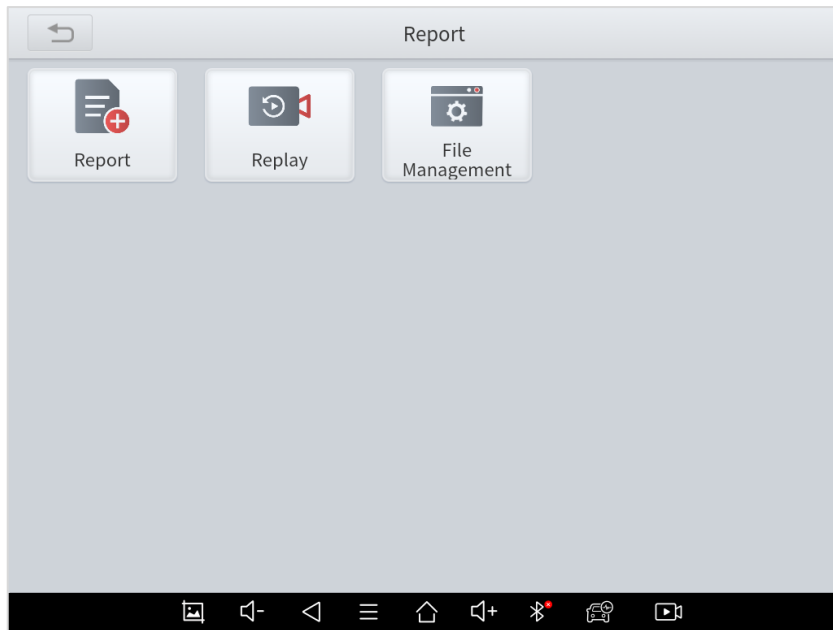

Figure 6-1 Sample of Report

6.1. REPORT

This feature provides a history of diagnostic reports, where you can view and delete the vehicle's diagnostic reports according to your needs.

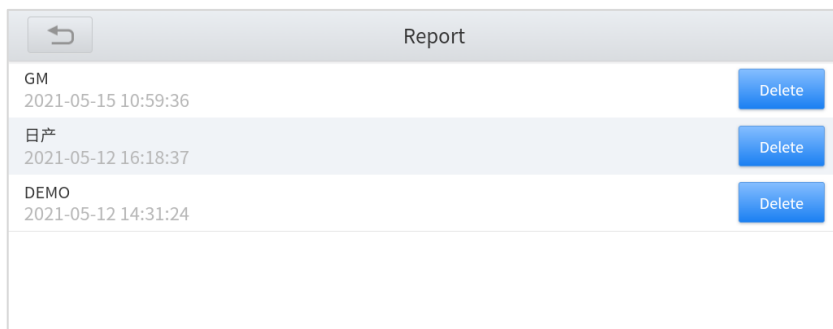

Figure 6-2 Sample of Report List

When you open the report, located in the header of the table is the studio information you filled in advance in the system setup, then the information of the vehicle, including the Diagnostics date and time, VIN, vehicle brand, Diagnostics path, etc., as shown as below:

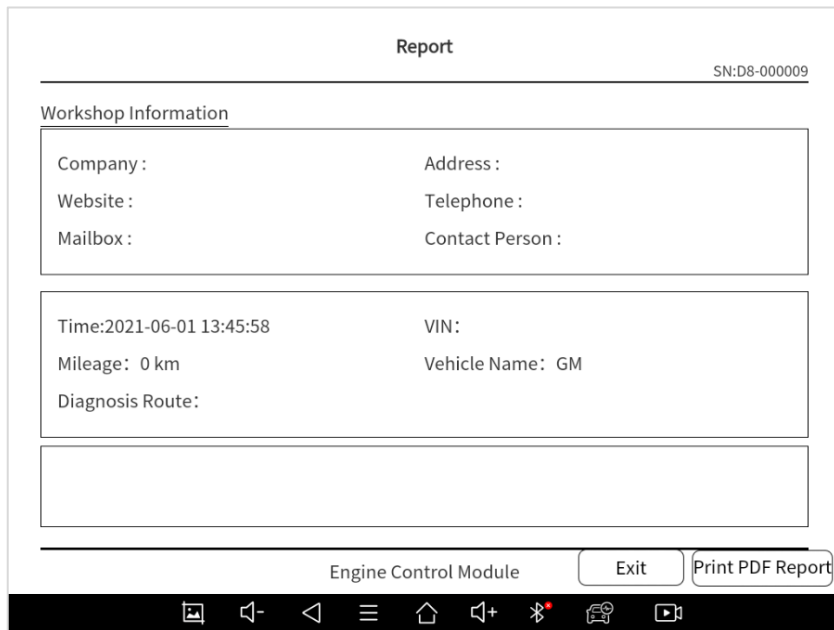

Figure 6-3 Sample of Report

■ Print PDF Report

As you can see, you also could click " **Print PDF Report** " at the bottom right corner to output the pdf report. If you need to close the report, you could tap on the button "Exit".

Please follow the below steps to print your report ▼

Step 1: Install an APP that can drive your target printer. Add the printer and input the IP address of the printer in the APP, or you can contact your dealer for help.

Step 2: Back to the Android main menu, go to Settings -> Printing-> Turn the printer on.

Step 3: Report-> Choose report-> Print PDF Report-> Print

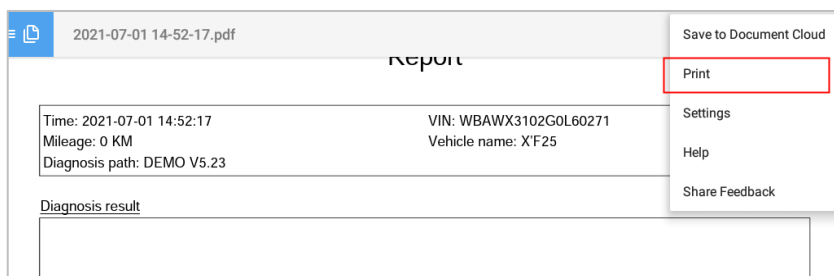

Figure 6-4 Sample of How to Print Report, Screen 1

Step 4: Click the top-left corner of the screen and choose the printer you added before. Then click the button on the right to print.

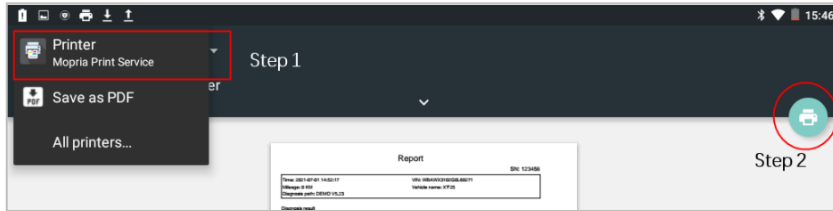

Figure 6-5 Sample of Report, Screen 2

6.2. REPLAY

This function allows you to replay the living data recorded during the Diagnostics process.

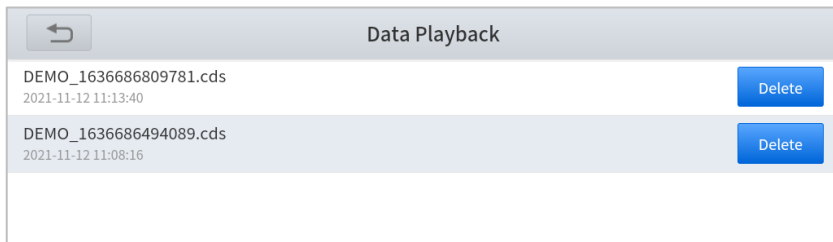

Figure 6-6 Sample of Data Playback, Screen 1

Before replaying the living data, please make sure you click on the "Save to Reference" button during the Diagnostics

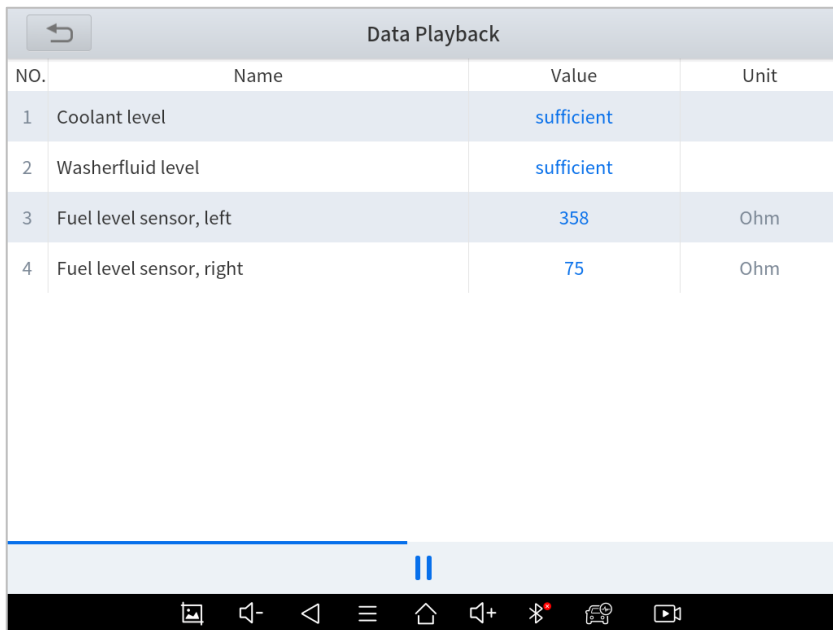

Figure 6-7 Sample of Data Playback, Screen 2

6.3. FILE MANAGER

This function allows you to check and delete files on the device. Please use this function under the guidance of professionals. Ordinary users are not recommended to use it by themselves!

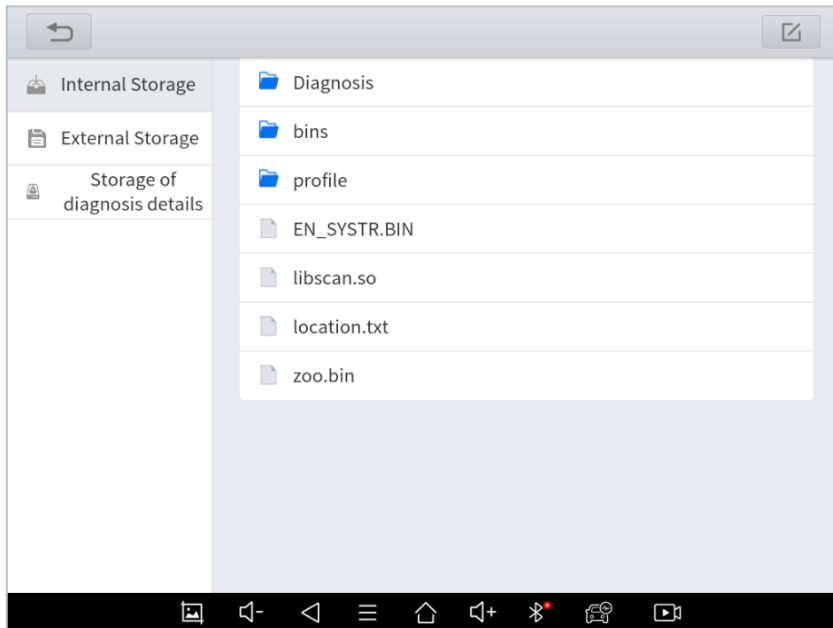

Figure 6-8 Sample of File Manager

7 SETTINGS



Click the Settings button to adjust the default settings and view the information on the D9 SMART DIAGNOSTICS SYSTEM. There are several options available in the system settings:

- Language
- Units
- Bluetooth
- My Workshop Info
- VCI Info
- About

7.1. LANGUAGE

The languages supported by this device are listed in **Settings**. In areas outside the English area, the default language is English and the local official language. Users can switch between English and local official languages on the device by themselves. If you need to switch other languages, please contact the dealer to unbind the current language configuration and rebind it to the language configuration you need to switch. After the configuration is successfully changed, you can switch the target language.

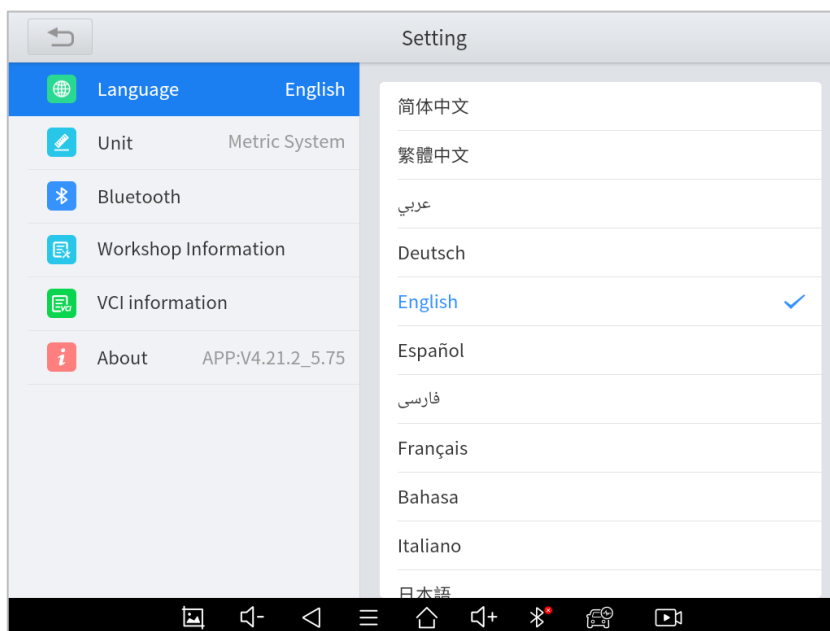

Figure 7-2 Sample of Language Selection

① This will only change the language of the APP. If you want to change the system language, please go to Android Settings.

■ How to change the language of your software?

- **Step1:** Contact your dealer and leave a message about the language you need and the S/N of your device, The technician will modify the language configuration for you in the background.
- **Step2:** Settings->Language->Choose language
- **Step3:** OS Settings->Language & input->Choose Language
- **Step4:** Back to Updates to pull all packages again

7.2. UNITS

You can switch the unit used by the system. D9 provides you with metric, imperial, and U.S. units. You can directly click on the unit when you need it, after the switch is successful, a blue checkmark will be shown behind the unit's name.

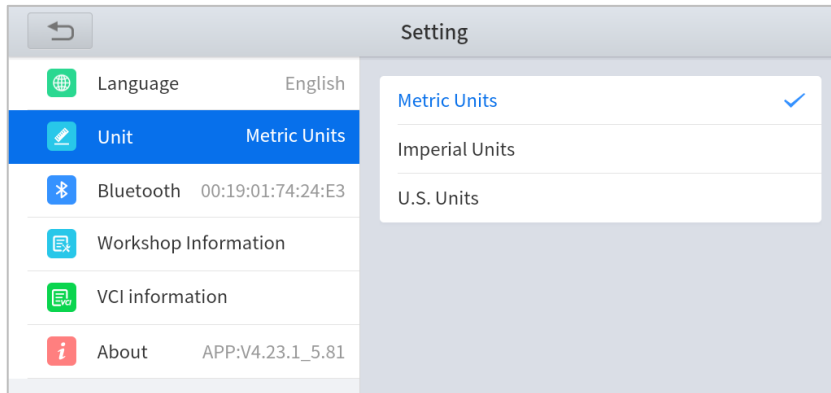

Figure 7-3 Sample of Units Selection

7.3. BLUETOOTH

You can check the Bluetooth connection status here. If you meet any communication issues, please check the Bluetooth status first.

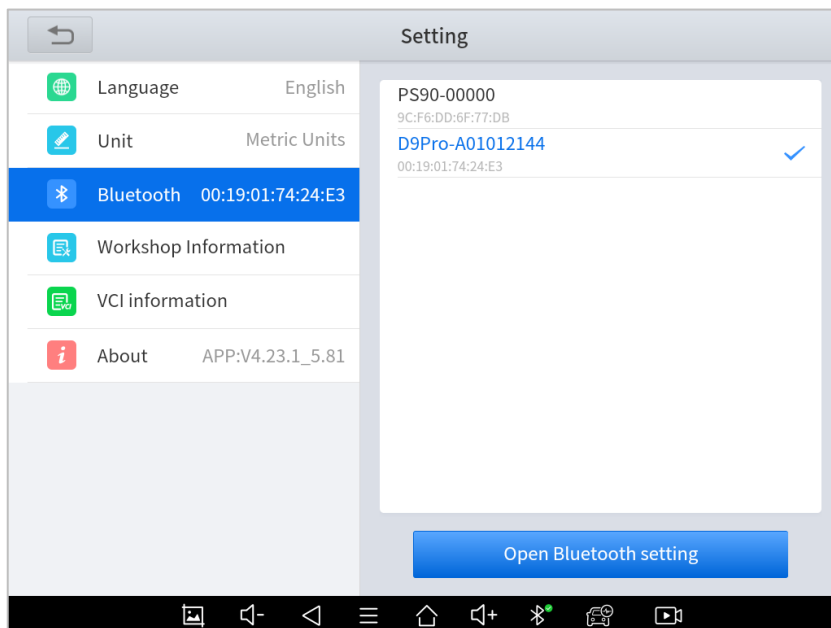

Figure 7-4 Sample of Bluetooth Selection

7.4. MY WORKSHOP INFO

Click on **My Workshop Information**, you can input your workshop information here. As shown in the figure below, you just need to fill in the valid information in the corresponding column and click "**SUBMIT**". And then it will show your workshop information in the report when you generate a diagnostic report, including your company name, address, website, telephone, and mailbox.

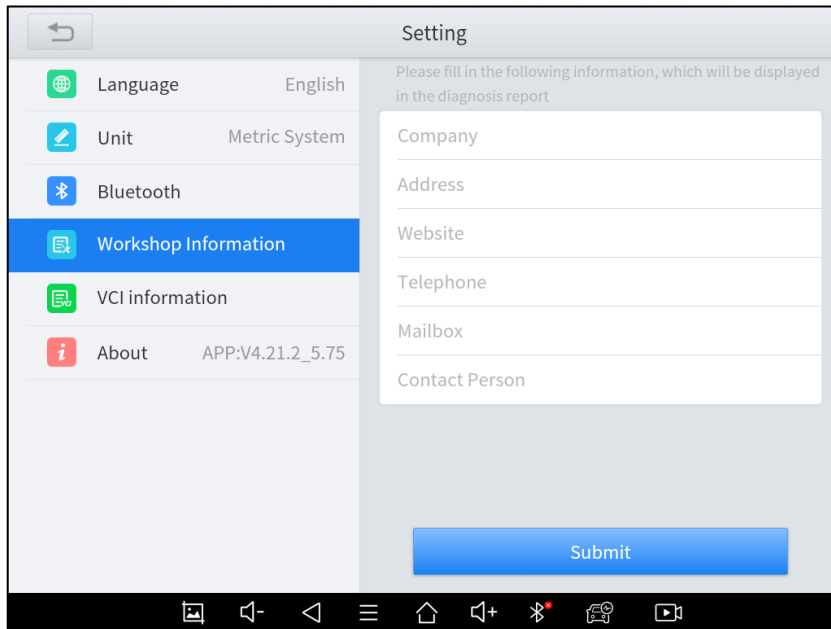

Figure 7-5 Sample of Workshop Information

7.5. VCI INFORMATION

You can view the VCI information here, including the VCI firmware name, the latest firmware version, the currently used firmware version, and the VCI firmware type. If the current firmware version is lower than the latest firmware version, you can choose to update your firmware version and click "**Update VCI Firmware**" to complete the operation.

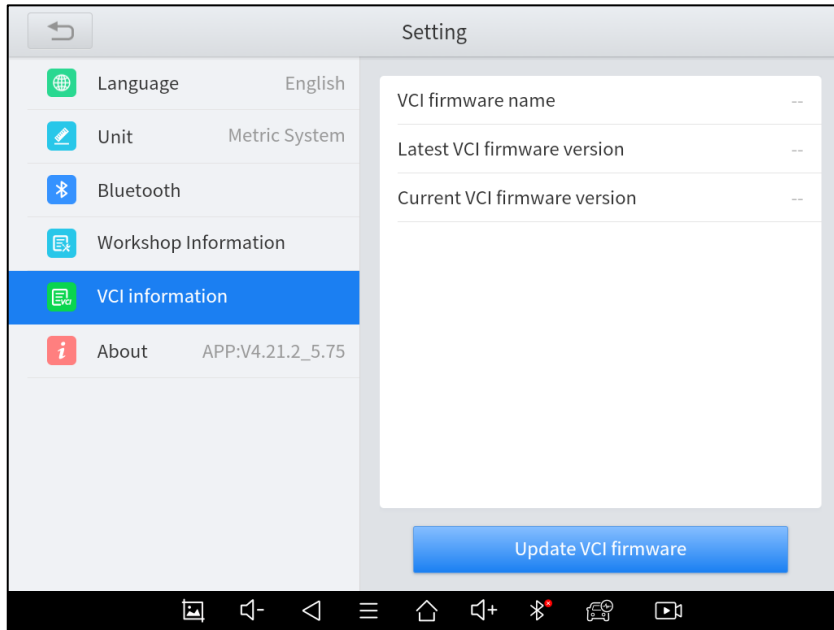

Figure 7-6 Sample of VCI Firmware Information

ⓘ Before updating the VCI Firmware, please ensure the tablet's connection to the Internet is stable.

7.6. ABOUT

Tap on **ABOUT**, you can check the serial number and APP version here.

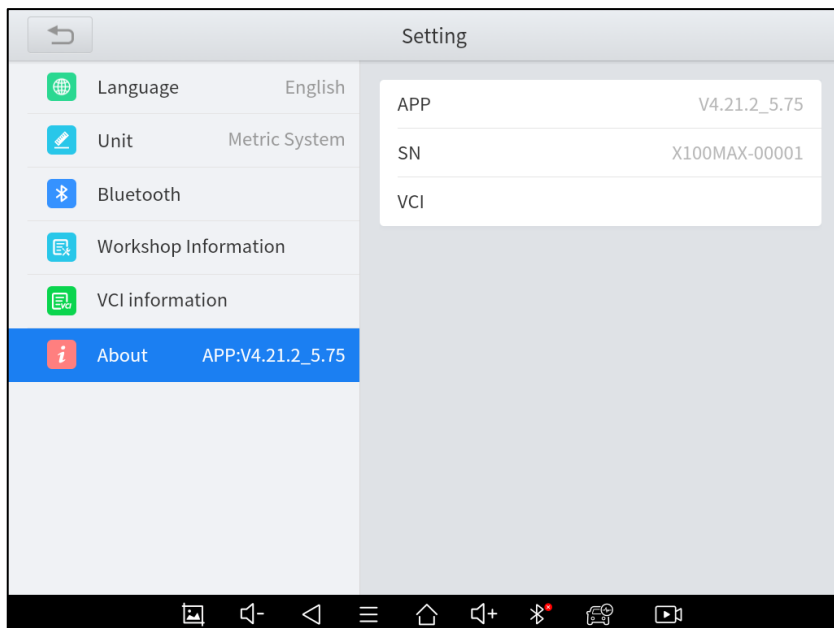

Figure 7-7 Sample of About Information

8 REMOTE ASSISTANCE

Tap on "**Remote**" to start the TeamViewer quick support program, which is a simple, fast, and secure remote-control screen. You can use this application to enable them to control your tablet on a PC through the TeamViewer software, thereby obtaining temporary remote support from the Xtool technical support center.

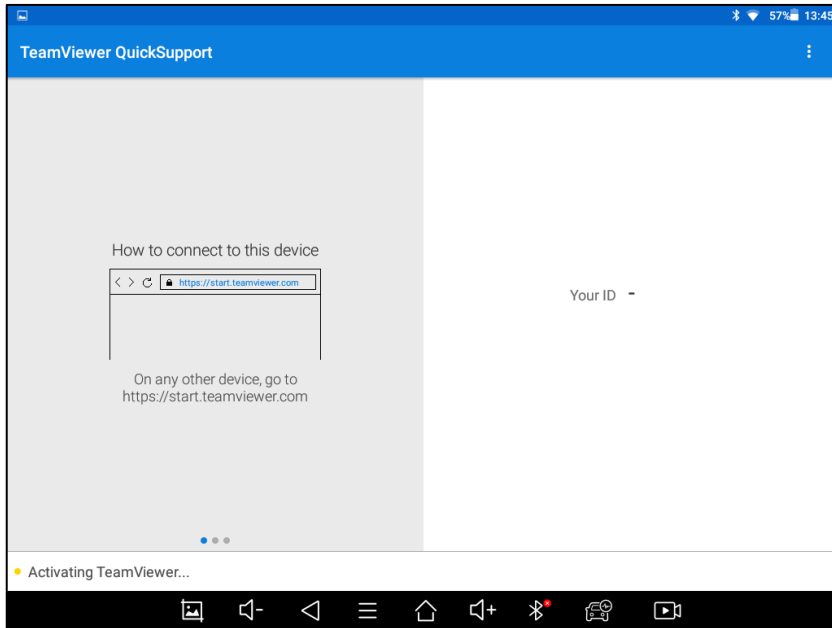

Figure 8-1 Sample of Activating Team Viewer, Screen 1

Tablets and mobile devices running TeamViewer are identified by a globally unique ID. When the remote application is started for the first time, the ID will be automatically generated according to the hardware characteristics and will not be changed in the future. This TeamViewer ID can individually access all TeamViewer clients.

Before launching the remote desktop application, make sure that the tablet is connected to the Internet so that you can access the tablet to receive remote support from a third party. If you encounter problems and are not able to solve them, you could open this application and ask for remote assistance.

To obtain remote support from your partners or Xtool After-service Center:

1. Turn on the power of the tablet.
2. Click **Remote** in the Diagnostics application. The TeamViewer screen is displayed, and the device ID will be generated.
3. Your partner must install the remote-control software on his/her tablet by downloading the full version of the TeamViewer program (<http://www.teamviewer.com>) online, and then start the software on his/her tablet at the same time, to provide support and remote control of the tablet.
4. Provide your ID to the partner or Xtool technician, and then wait for him/her to send you a remote-control request.
5. A pop-up window will be shown asking you to confirm to allow the remote-control program to control your device.

6. Click **Allow** to accept, or click **Reject** to reject.

9 FAQ

Q1: FAILED TO GENERATE DIAGNOSTICS REPORT

1. Currently only perform diagnostic functions, that is, read ECU information, read code and clear code, live data, freeze frame, which can trigger a diagnostic report. Other functions, such as immobilization and maintenance services will not be displayed in the report.
2. After entering the Diagnostics menu, you need to perform one specific function before the system can generate a Diagnostics report normally. After the Diagnostics is completed, you need to step back to the previous menu step by step to generate the Diagnostics report successfully. If the APP is killed directly, the report also cannot be triggered.
3. If the report still cannot be generated after troubleshooting according to the above prompts, please try to exit the APP, enter the system settings, and then choose to clear the APP cache.

Enter the path: Setting>>Apps>>Diagnostics>>Clear Cache

- Sample as follows:

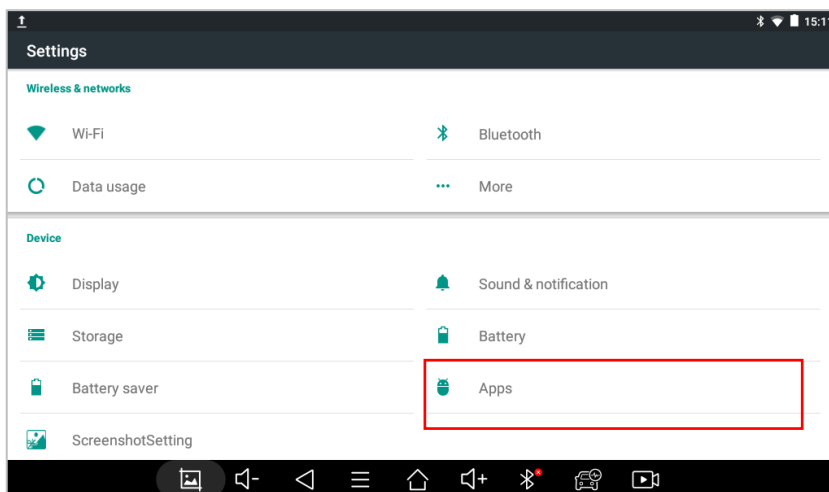

Fig 9-1 Sample1: How to clear APP cache

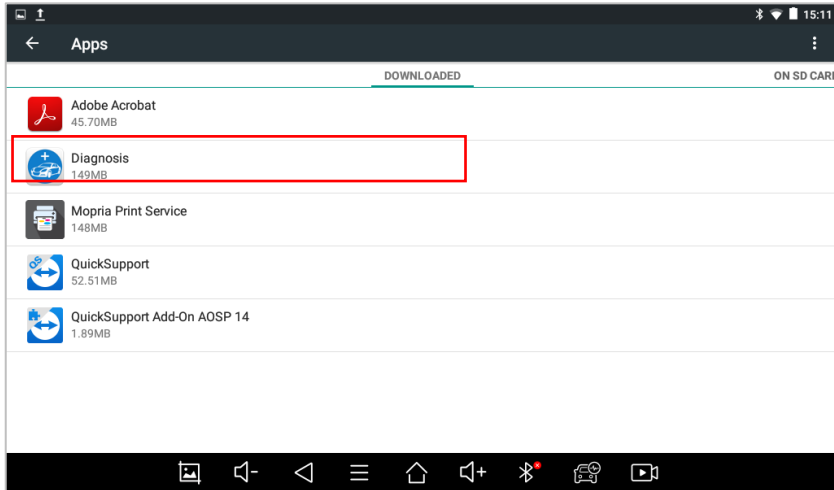

Fig 9-2 Sample1: How to clear APP cache

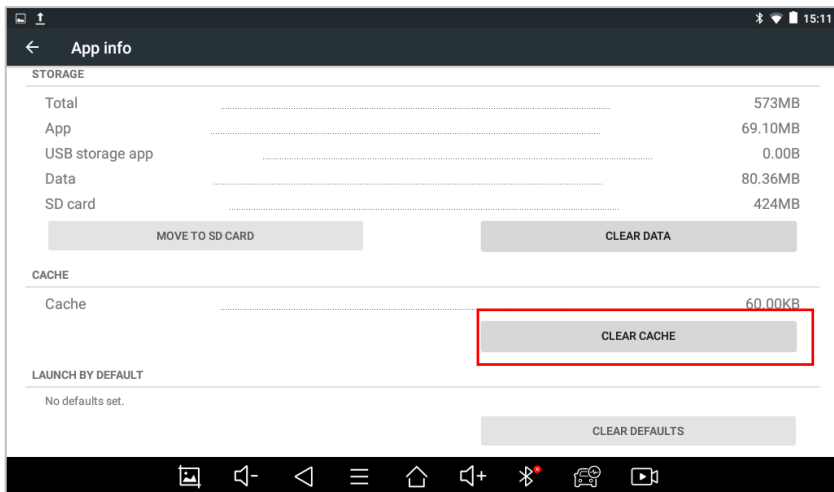

Fig 9-3 Sample1: How to clear APP cache

Q2: HOW TO PRINT DIAGNOSTICS REPORT

The XTOOL device is compatible with third-party print drivers. You can download the printer driver you need in the browser that comes with the tablet to install it, and then set your printer in the OS settings. After the setting is completed, you can print it in the **Report**.

Q3: FAILED TO EXTRACT FILES

Since the XTOOL tablet is equipped with an Android system, you have to confirm the system type of receiver.

For Android: supports transferring files via Bluetooth, USB cable, etc.;

For IOS: only supports transferring files through a wired connection (Bluetooth connection is not available).

Q4: MAILBOX SUPPORTED

The Diagnostics tablet supports various mailboxes, including Hotmail, Outlook, Yahoo, Gmail, etc. When you set up the email, please make sure that the email client configuration address you entered is correct.

Due to the adjustment of Google's security policy, starting from May 31, 2022, the Android system of this device will no longer support the email client to log in to the Gmail account. To use the Gmail mailbox service, please log in to the web version of Gmail using a browser.

Q5: HOW TO MAKE AN APPOINTMENT FOR REMOTE SUPPORT

Please contact your dealer, or send an email to our technical support center. (Email address: supporting@xtooltech.com) And our technical support team will confirm the time of remote support with you.

Q6: HOW TO GENERATE AND UPLOAD DIAGNOSTIC LOG FILES

The A80 tablet will automatically generate and store the diagnostic logs. When the device is connected to the Internet, it will automatically upload all the stored diagnostic logs to the backend system.

Q7: HOW TO SWITCH LANGUAGE

1. Contact your dealer and leave a message about the language you need and the S/N of your device, The technician will modify the language configuration for you in the backend system.
2. **Settings->Language->**Choose language
3. Back to **Updates** to update all the software again

Q8: FAILED TO DIAGNOSE VEHICLE

1. Contact your dealer to confirm whether the vehicle model is supported by the scan tool you owned.
2. Check whether the vehicle is properly connected (e.g. whether the ignition is ON, and the Diagnostics of some vehicles need to turn on the engine), If your tablet is equipped with a VCI box, please check the status of the VCI box indicator.
3. Confirm whether you have entered the correct Diagnostics menu.
4. Confirm whether the **AUTO-SCAN** function can assist you to enter the correct Diagnostics menu, or whether the **OBDII** function works.
5. Check whether the software is the latest version, if not, please update to the latest version first.

Q9: FAILED TO ACTIVATE OR REGISTER

- For 'Activation Failed'

Generally caused by network instability, please switch to a more stable network and try to activate again.

- For 'Registration Failed'

Generally, it is caused by the connection timeout or the sending timeout, please check whether you have blocked the outgoing network traffic to non-US regions like China. We recommend that you unblock and try to register again.

Q10: FAILED TO TURN ON WHEN CHARGING

In the charging state, you need to first press the power button to light up the screen (showing the charging status). Then press and hold the power button for 4-5 seconds until the boot animation is shown on screen.

Q11: FAILED TO OPEN THE DIAGNOSTICS APP

A11: With PROMPT “Sync your device. the device has been offline for more than 30 days. you should connect INTERNET SYNC DEVICES TO THE NETWORK STATUS!” , the tablet has to connect to the network every 30 days, otherwise, the Diagnostics app will be locked and disabled until the device is connected to the network. If you have ruled out the network problem and ensured that the device can be connected to the Internet normally, and your device still cannot use the diagnostic function, please contact our technical team (supporting@xtooltech.com)

Q12: FAILED TO ENTER VEHICLE MENU

If you encounter the following two prompts, please delete the package and download it again to diagnose

- ‘Failed’

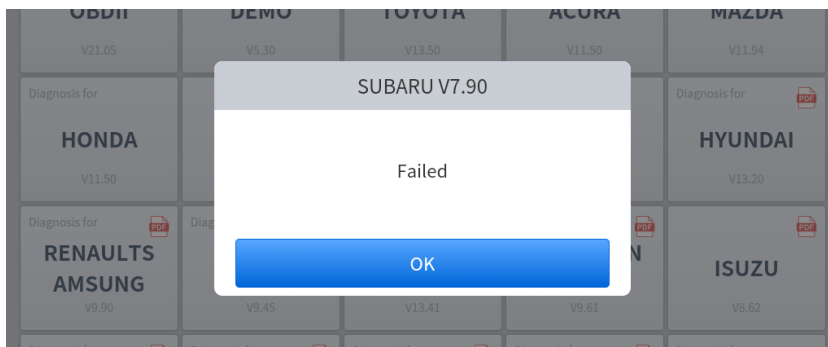

- ‘License exception’

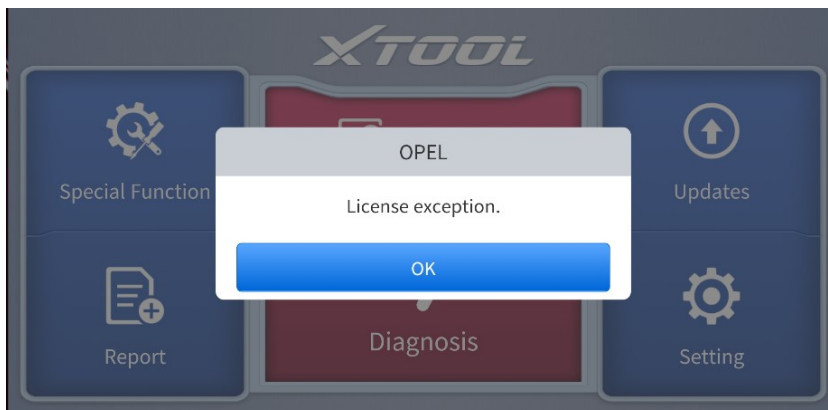

It's usually caused by an uncompleted software package under stable network status, users could delete the corresponding software and redownload it.

10 WARRANTY & SERVICES

Shenzhen Xtooltech Intelligent Co., LTD.(the Company) warrants to the original retail purchaser of this XTOOL device that should this product or any part thereof during normal usage and under normal conditions be proven defective in material or workmanship that results in product failure within one year from the date of purchase, such defect(s) will be repaired, or replaced (with new or rebuilt parts) with Proof of Purchase, at the Company's option, without charge for parts or labor directly related to the defect(s).

The Company shall not be liable for any incidental or consequential damages arising from the use, misuse, or mounting of the device.

1. This warranty does not apply to:
2. Products subjected to abnormal use or conditions, accident, mishandling, neglect, unauthorized alteration, misuse, improper installation/repair, or, improper storage;
3. Products whose mechanical serial number or electronic serial number has been removed, altered, or defaced;
4. Damage from exposure to excessive temperature or extreme environmental conditions;
5. Damage resulting from connection to, or use of any accessory or other product not approved or authorized by the Company;
6. Defects in appearance, cosmetic, decorative, or structural items such as framing and non-operating parts;
7. Products damaged from external causes such as fire, dirt, sand, battery leakage, blown fuse, theft, or improper usage of any electrical source.

SHENZHEN XTOOLTECH INTELLIGENT CO., LTD

Company address: 17&18/F, Building A2, Creativity City, Liuxian Avenue, Nanshan District, Shenzhen, China

Factory address: 2/F, Building 12, Tangtou Third Industrial Zone, Shiyan Street, Baoan District, Shenzhen, China

Service-Hotline: 0086-755-21670995/86267858

Email: marketing@xtooltech.com

supporting@xtooltech.com

Fax: 0755-83461644

Website: www.Xtooltech.com